

## GOBI GRENADIER SUV 2024 ROOF RACK INSTALLATION INSTRUCTIONS

### Guidelines:

When using Load Carriers and Accessories, the user must understand the precautions. The points listed below will assist you in using the rack /carrier system and will encourage safety.

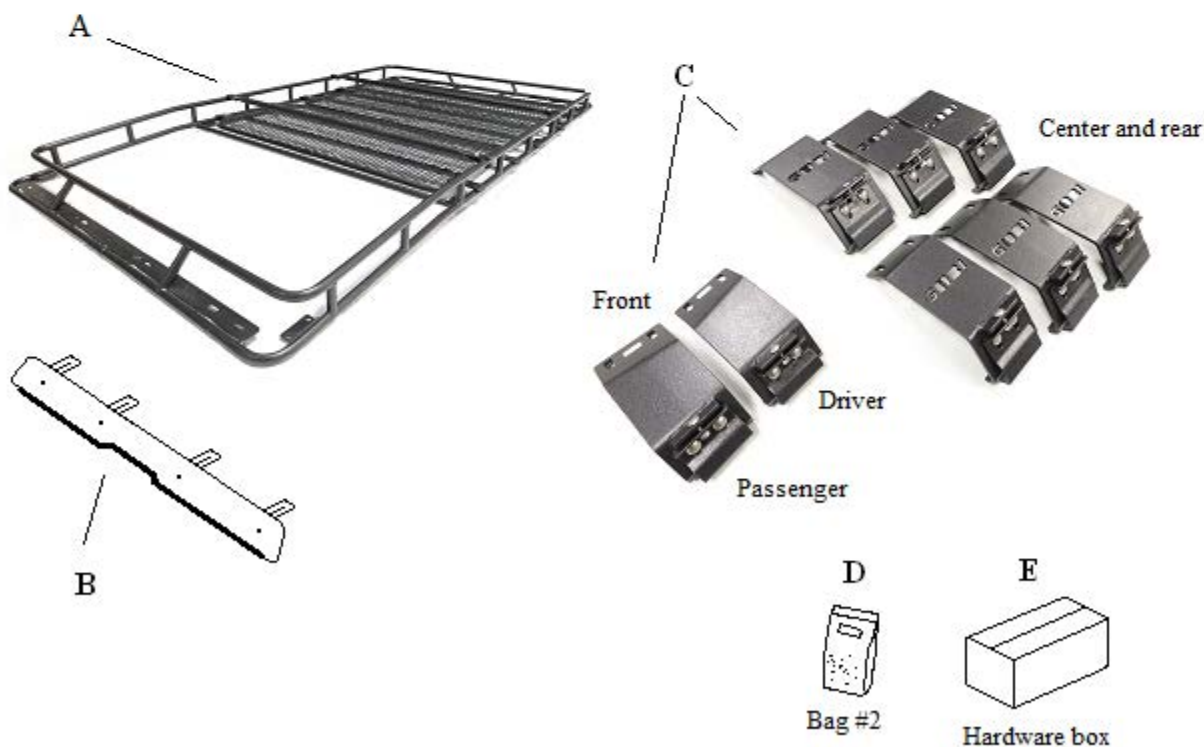
- For quality fits and safty, use only the recommended rack or accessory. Do not assume an accessory will fit, always check with dealer when obtaining new accessories. Use only approved accessories on load carriers. Using other brands will void your warrenty.
- Make sure all knobs, bolts, screws, straps, and locks are firmly attached, tightened and locked before every trip. Knobs, bolts, screws, straps, and locks must be periodically inspected for signs of wear, corrosion, and fatigue. Check your load at stops during the trip to insure continued fastening security.
- Check local and state laws governing projection of objects beyound the width of a vehicle. **Be aware of the width and height of your cargo since low clearance branches, bridges, and parking garages can affect the load** All cargo will affect the vehicle's driving behavior. Never drive with any lock, know, or rack in an open or unlocked position. All long loads such as, but not limited to sailboards, surfboards, kayaks, canoes, and lumber must be tied down front and rear to the bumpers or tow hooks, of the vehicle.
- Remove your rack accessories when they are not in use, before intering car washes, prior to taking in your vehicle for service, and whenever clearance may be an issue.
- All locks must be turned and moved periodically to insure smooth operation. Use graphite or similar dry lubricant to help this. Locks are designed to deter vandalism and theft. Remove valuable gear if your vehicle is unattended for an extended period. Place at least one key in the glove compartment.
- For safety to your vehicle and rack system, obey all posted speed limits and traffic cautions. Adapt your speed to the conditions of the road and the load being carried.
- Do not use load carriers and accessories for purposes other than those for which they were designed. Do not exceed their carrying capacity.
- Consult with your dealer if you have any questions regarding the operations and limits of this product. Review all instructions carefully.

**USE THE SUPPLIED ANTI-SEIZE LUBRICANTE ON ALL SCREWS**

## GOBI GRENADIER SUV 2024 ROOF RACK INSTALLATION INSTRUCTIONS

**Included in kit**

Letter	Description	Location	Quantity
A	GOBI GRENADIER SUV 2024 ROOF RACK	Main box	1
B	GOBI GRENADIER WIND DEFLECTOR	pre-assembled	1
C	GOBI GRENADIER ROOF RACK SUPPORT BRCKETS COMPLETE	banded to rack	8
D	GOBI WIND DEFLECTOR HARDWARE CONTENTS: 4- Wind deflector support brackets 85" 4- 1/4-20 x 3/4" Button head screw SS 8- 1/4" Black Nylon flat washer 4- 1/4" Nylock SS	BAG #2 Strapped to Wind deflector	1
E	GOBI BRACKET TO ROOF RACK HARDWARE CONTENTS: 16- 3/8-16 x 1" Hex head screw SS 32- 3/8" Flat washer SS 16- 3/8" Nylock nut SS 8- Rubber black pad 1- Anti-Seize lubricant	Hardware Box	1





## GOBI GRENADIER SUV 2024 ROOF RACK INSTALLATION INSTRUCTIONS

Clean top of gutter  
of all dirt and debris



Clean the underside  
of gutter of all dirt  
and debris

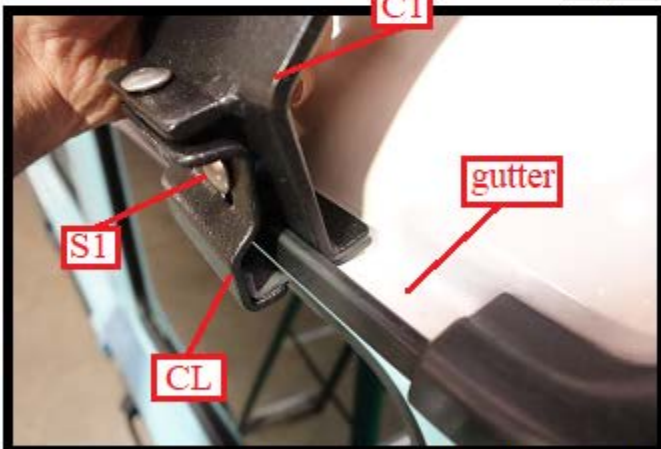
**Fig. 1**

As shown in Fig. 1 by red arrows, clean the entire inner and lower length of both the driver and passenger side roof top gutters of dirt and debris.

**Fig. 2**

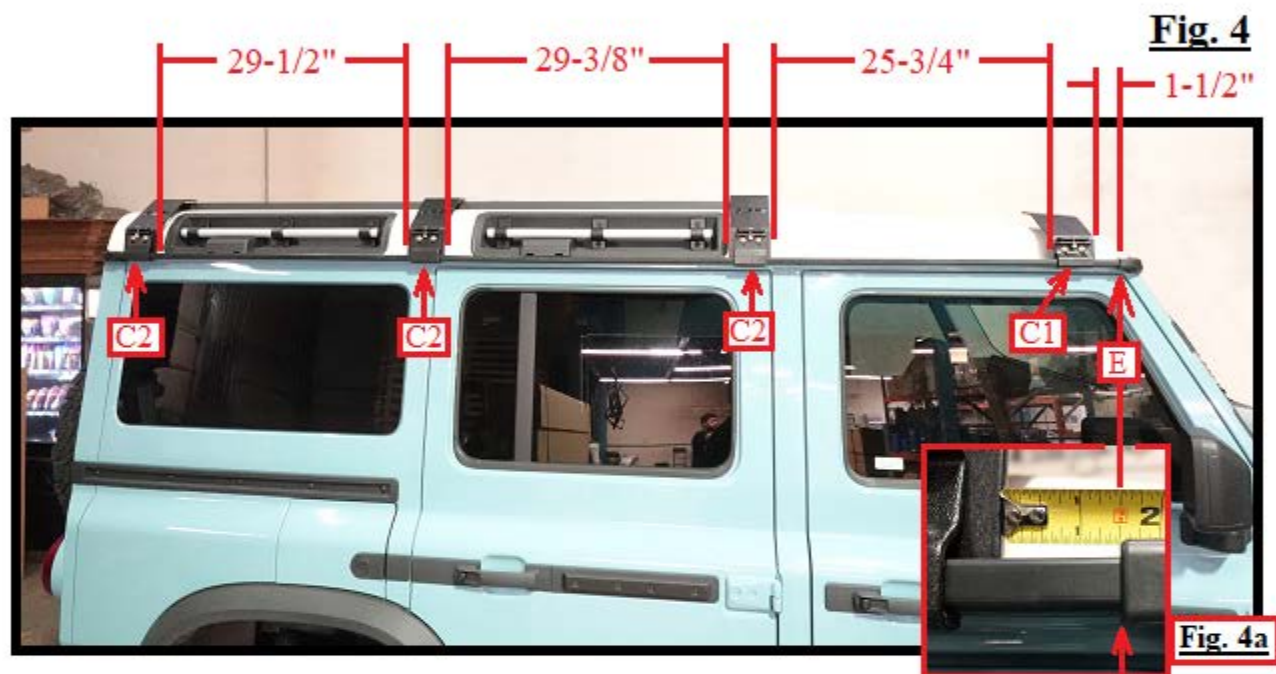


**Fig. 3**



As shown in Fig. 2 and Fig. 3, remove the passenger side front roof rack support bracket (C1) from your hardware kit. Place the support bracket (C1) as shown in Fig. 3 onto the forward most section of the gutter above the passenger side door. Make certain clamp screws (S1) are loose enough to allow clamp (CL) to fit outside the gutter as shown in Fig. 3.

## GOBI GRENADIER SUV 2024 ROOF RACK INSTALLATION INSTRUCTIONS



As shown in Fig.4, set the front passenger side support bracket (C1), 1-1/2" from the front gutter molding edge (E) shown in close in Fig. 4a. Then follow by setting the remaining 3 identical roof rack support brackets (C2) onto the roof top gutter in the same procedure. Use the above dimensions to place each support bracket (C2) in the correct location on the roof top gutter.



## GOBI GRENADIER SUV 2024 ROOF RACK INSTALLATION INSTRUCTIONS

**Fig. 5**

As shown in Fig. 5, by red a arrow. Pull the main support bracket (C) towards the gutter away from the roof top and push the support bracket clamp (CL) shown by a red arrow towards the gutter and towards the roof top. Then snug down screws (S1), leaving some play for later adjustment.

Apply this procedure to all the remaining support brackets on the passenger side and repeat the same procedure for the driver's side.

**GOBI GRENADIER SUV 2024 ROOF RACK  
INSTALLATION INSTRUCTIONS****Fig. 6**

As shown in Fig. 6, all support brackets (C1) and (C2) are properly installed and separated ready for roof rack installation.



## GOBI GRENADIER SUV 2024 ROOF RACK INSTALLATION INSTRUCTIONS

**Fig. 7**

Grenadier roof rack complete

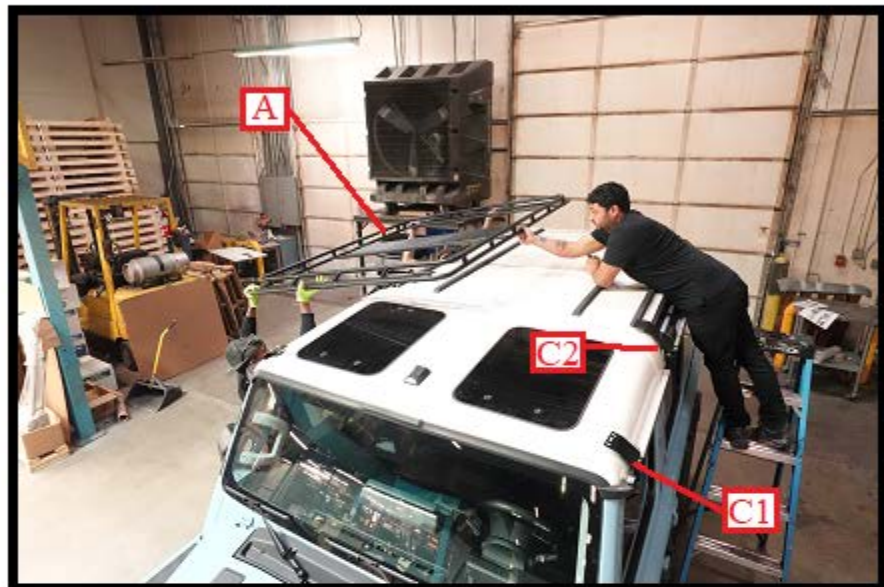
**Fig. 8**

Grenadier roof rack insert

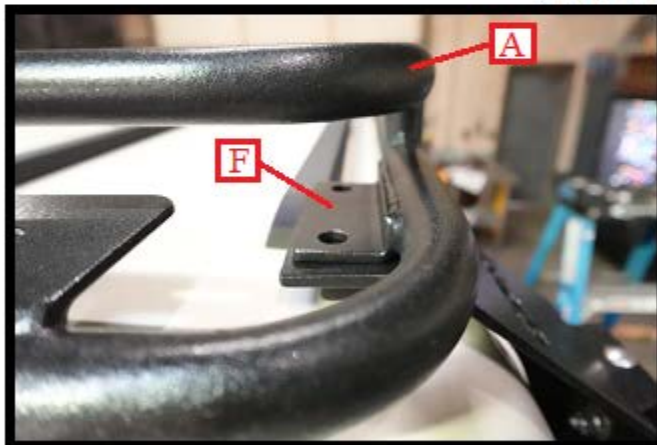
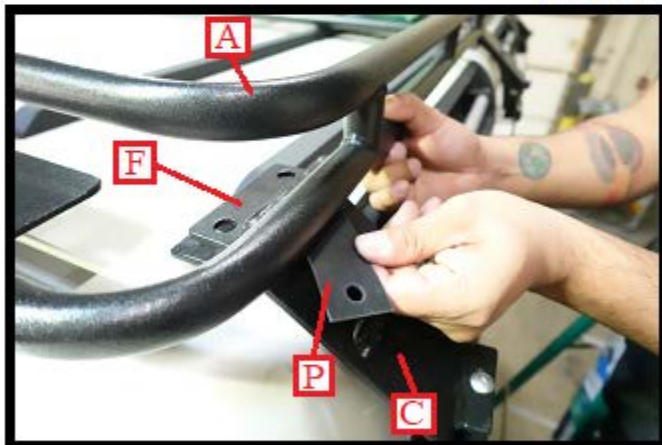
**Fig. 9**

As shown in Fig. 7, when your Gobi Grenadier roof rack arrives it will come with one, two or three roof rack inserts. Roof rack insert shown in Fig. 8. Prior to installing your Gobi Grenadier roof rack, we suggest removing all inserts so that the roof rack is easier to lift and install. Each insert has four clamps, only two clamps on one side need to be removed using two 9/16" ratchet wrenches. The other two opposite clamps only need to be loosened then the insert can slide out and lifted for removal. Fig. 9 shows the Gobi Grenadier roof rack without the inserts and ready for roof rack installation.

## GOBI GRENADIER SUV 2024 ROOF RACK INSTALLATION INSTRUCTIONS

**Fig. 10**

With the help from some friends, lift the roof rack (A) and set the rack down onto all 8 roof rack support brackets (C1) and (C2) previously installed and shown in Fig. 6. Make certain to line up the 8 roof rack welded in flanges (F) shown in Fig. 11 with the 8 roof rack support brackets.

**Fig. 11****Fig. 12**

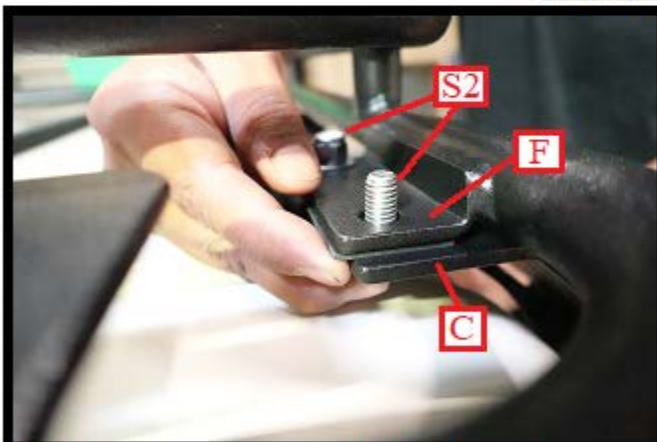
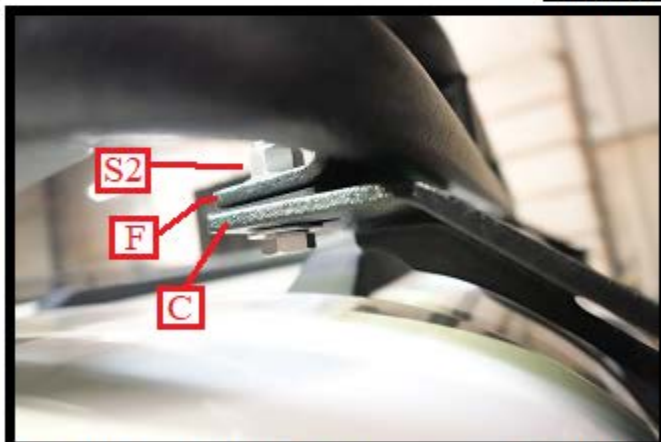
As shown in Fig. 11, make certain to rest all 8 welded in flanges (F) of roof rack (A) onto all 8 roof rack support brackets as shown in Fig. 12. As shown in Fig. 12, remove one rubber pad (P) from Bag #3 of your hardware kit and slip in between the roof rack and support bracket. Align the two rubber pad holes with the screws holes in roof rack flange (F) and support brackets (C).



## GOBI GRENADIER SUV 2024 ROOF RACK INSTALLATION INSTRUCTIONS

**Fig. 13****Fig. 14**

As shown in Fig. 13 and Fig. 14, remove one 3/8-16 x 1" hex head screw and one 3/8" flat washer (S2) and place up through the bottom of support bracket (C) then up through rubber pad (P) then up through roof rack flange (F).

**Fig. 15****Fig. 16**

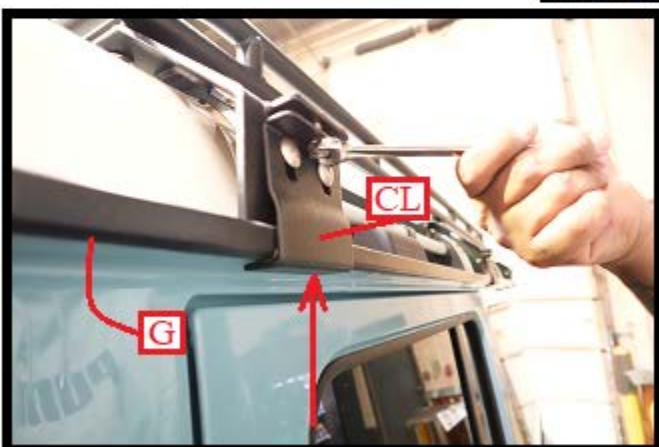
As shown in Fig. 15 and Fig. 16, place a second 3/8-16 x 1" hex head screw and 3/8" flat washer (S2) in the same manner up into support bracket (C) and roof rack flange (F). As shown in Fig. 15 and Fig. 16, thread onto each screw (S2) one 3/8" flat washer and one 3/8" nylock nut. Finger tighten in place and apply the same procedure to the remaining 7 other support brackets (C).



## GOBI GRENADIER SUV 2024 ROOF RACK INSTALLATION INSTRUCTIONS

**Fig. 17****Fig. 18**

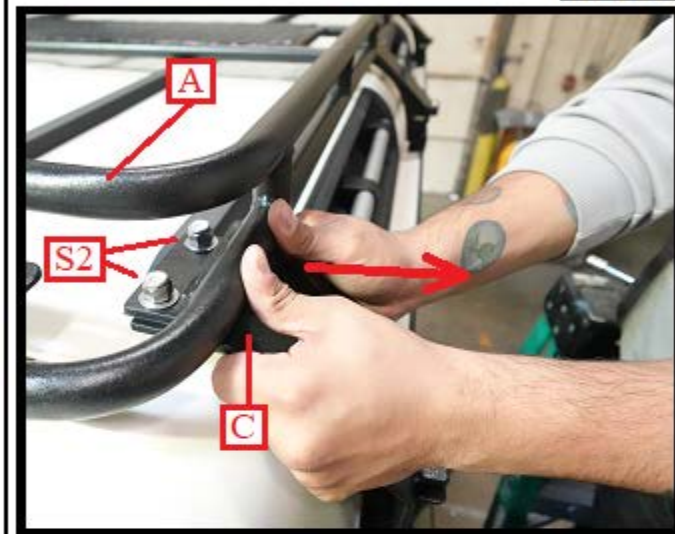
As shown in Fig. 17, pull the bottom of support bracket (C) away from the vehicle shown by red arrows and tight up against the inside outer edge of the gutter and hold in place. As shown in Fig. 18, tighten clamp (CL) using a 7/16" open end wrench so that the bottom of the clamp (CL) comes up tight against the bottom of the gutter as shown by a red arrow, do not fully tighten.

**Fig. 19****Fig. 20**

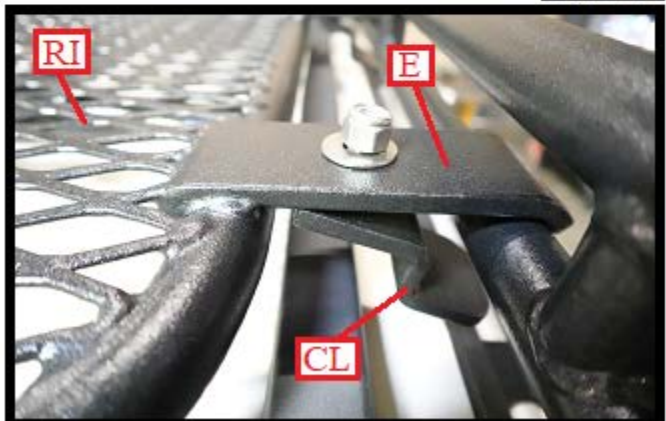
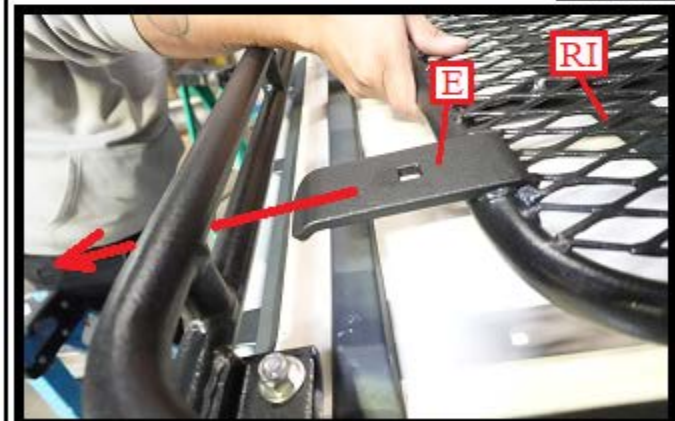
As shown in Fig. 19, use a 1/2" open or closed end wrench and snug down clamp (CL) against the outer edge of the gutter shown by a red arrow, do not fully tighten. As shown in Fig. 20, further tighten clamp (CL) upwards against the bottom of the gutter shown by a red arrow using a 7/16" open end wrench so that clamp (CL) is very tight up against the bottom of gutter (G). As shown in Fig. 19, continue by fully tightening screw (S1) using a 1/2" open or closed end wrench to fully tighten clamp (CL) against the outer edge of the gutter (G). Apply the same procedure to the remaining 7 support brackets (C).



## GOBI GRENADIER SUV 2024 ROOF RACK INSTALLATION INSTRUCTIONS

**Fig. 21****Fig. 22**

As shown in Fig. 21 and Fig. 22, pull back the top of support bracket (C) in the direction of the red arrow away from the roof rack (A). Hold in place and fully tighten both screws (S2) using a 9/16" ratchet and a 9/16" open or closed end wrench on the bottom. Apply the same procedure to the remaining 7 support brackets (C).

**Fig. 23****Fig. 24**

Reinstall roof rack inserts (RI) back in place on the roof rack by sliding one end of the insert ears (E) without clamps (CL) in between the upper and lower rack tubing shown in Fig. 23. Then slide the opposite side ears (E) with clamps (CL) over the lower rack tube shown in Fig. 24. Snug down the clamps (CL) shown in Fig. 24 then add the clamps (CL) back onto the side without the clamps and align the insert within the roof rack and tighten down all clamps (CL) in place using a 9/16" ratchet and 9/16" open or closed end wrench.



## GOBI GRENADIER SUV 2024 ROOF RACK INSTALLATION INSTRUCTIONS

**Fig. 25**

To install the Gobi Grenadier wind deflector, refer to the Gobi wind deflector installation instructions attached to the Gobi wind deflector which will be strapped to the roof rack upon delivery.



### INSTALLATION COMPLETE