

**GOBI TOYOTA 4 RUNNER 5TH GEN REAR
DRIVER SIDE LADDER
INSTALLATION INSTRUCTIONS**

The Gobi ladder must be inspected before each use to make certain attachments are secure, and for evidence of wear. Misuse of the ladder or failure to observe the manufacturer's instructions as to installation, proper attachment and maintenance will void any warranties that may be implied by law.

CAUTION

**"LADDER IS TO BE TRAVERSED UPON
ONLY
WHEN THE REAR DOOR TAIL GATE
AND LIFT GATE ARE FULLY
CLOSED AND LOCKED"**

**CAUTION: APPLY ANTI-SEIZE LUBRICANT TO ALL SCREWS
PRIOR TO INSTALLATION**

GOBI TOYOTA 4 RUNNER 5TH GEN REAR DRIVER SIDE LADDER INSTALLATION INSTRUCTIONS

Guidelines:

When using Load Carriers and Accessories, the user must understand the precautions. The points listed below will assist you in using the rack /carrier system and will encourage safety.

- For quality fits and safty, use only the recommended rack or accessory. Do not assume an accessory will fit, always check with dealer when obtaining new accessories. Use only approved accessories on load carriers. Using other brands will void your warrenty.
- Make sure all knobs, bolts, screws, straps, and locks are firmly attached, tightened and locked before every trip. Knobs, bolts, screws, straps, and locks must be periodically inspected for signs of wear, corrosion, and fatigue. Check your load at stops during the trip to insure continued fastening security.
- Check local and state laws governing projection of objects beyound the width of a vehicle. **Be aware of the width and height of your cargo since low clearance branches, bridges, and parking garages can affect the load** All cargo will affect the vehicle's driving behavior. Never drive with any lock, know, or rack in an open or unlocked position. All long loads such as, but not limited to sailboards, surfboards, kayaks, canoes, and lumber must be tied down front and rear to the bumpers or tow hooks, of the vehicle.
- Remove your rack accessories when they are not in use, before intering car washes, prior to taking in your vehicle for service, and whenever clearance may be an issue.
- All locks must be turned and moved periodically to insure smooth operation. Use graphite or similar dry lubricant to help this. Locks are designed to deter vandalism and theft. Remove valuable gear if your vehicle is unattended for an extended period. Place at least one key in the glove compartment.
- For safety to your vehicle and rack system, obey all posted speed limits and traffic cautions. Adapt your speed to the conditions of the road and the load being carried.
- Do not use load carriers and accessories for purposes other than those for which they were designed. Do not exceed their carrying capacity.
- Consult with your dealer if you have any questions regarding the operations and limits of this product. Review all instructions carefully.

**PLEASE READ ALL INSTALLATION INSTRUCTIONS
PRIOR TO INSTALLATION**

GOBI TOYOTA 4 RUNNER 5TH GEN REAR DRIVER SIDE LADDER INSTALLATION INSTRUCTIONS

Included in kit

Letter	Description	Location	Quantity
A	GOBI TOYOTA 4 RUNNER 5TH GEN REAR DRIVER LADDER	Main box	1
B	LOWER LADDER MOUNTING BRACKET	strapped to ladder	1
C	LADDER HANGER PLATE	strapped to ladder	1
D	LADDER BASE SUPPORT PLATE	strapped to ladder	1
E	GOBI LADDER MOUNTING HARDWARE CONTENTS: 2- 5/16" Nuts SS 2- 5/16" Lock washer SS 2- 3/8" Flat washer SS 1- 1/8" Allen wrench 1- 3/16" Short Allen wrench 1- Pack Anti-seize 2- 5/16-18 x 1" SS Button head screws 2- 5/16" SS Flat washers 2- 5/16" SS Lock washers	BAG #1 Pre-assembled to bottom of ladder	1

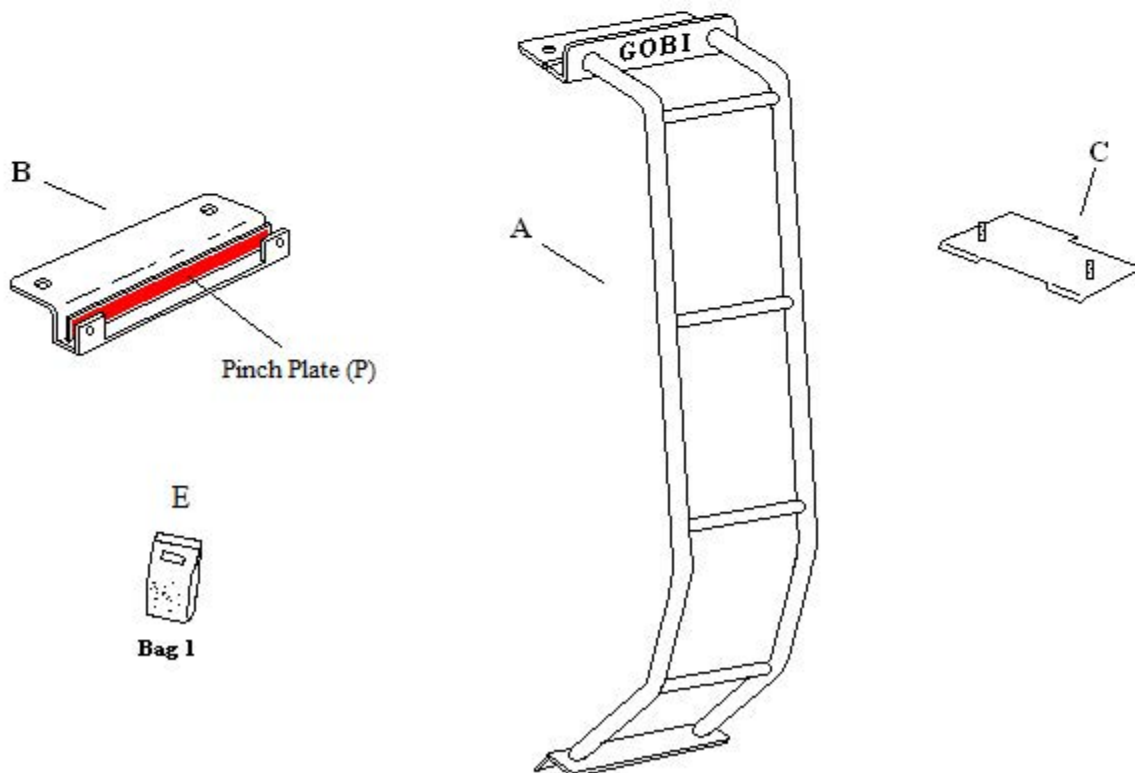

GOBI TOYOTA 4 RUNNER 5TH GEN REAR DRIVER SIDE LADDER INSTALLATION INSTRUCTIONS

**Fig. 1**

As shown in Fig. 1, using a measuring tape, mark out 3-3/8" from the inside edge of the roof top trim and place a piece of masking tape down on both the body and rear door. As shown by black arrows, clean the area on the rear door with denatured alcohol.

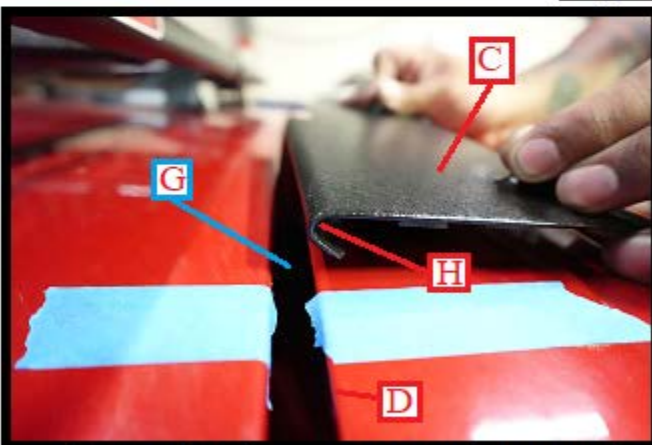
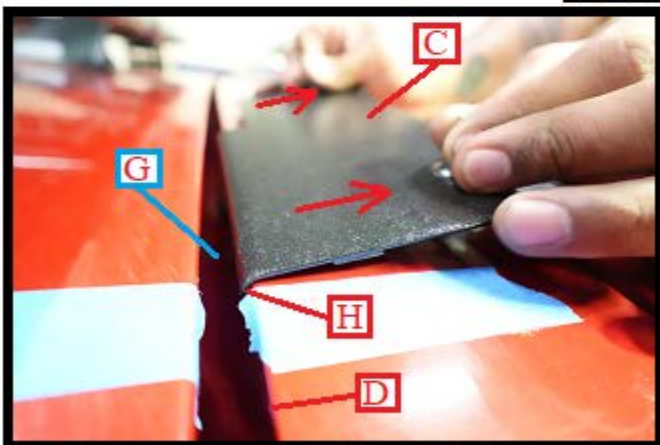
Fig. 2**Fig. 3**

As shown in Fig. 2, remove hanger plate (C) from your parts kit. As shown in Fig. 2 and Fig. 3, install hanger plate (C) into the rear door upper gap (G) and pull in the direction of the arrows using the threaded studs as pull points. Make certain that hanger plate (C) left edge is in line with the masking tape marker and hook (H) is in full contact with the top edge (D) of the rear door.

GOBI TOYOTA 4 RUNNER 5TH GEN REAR DRIVER SIDE LADDER INSTALLATION INSTRUCTIONS

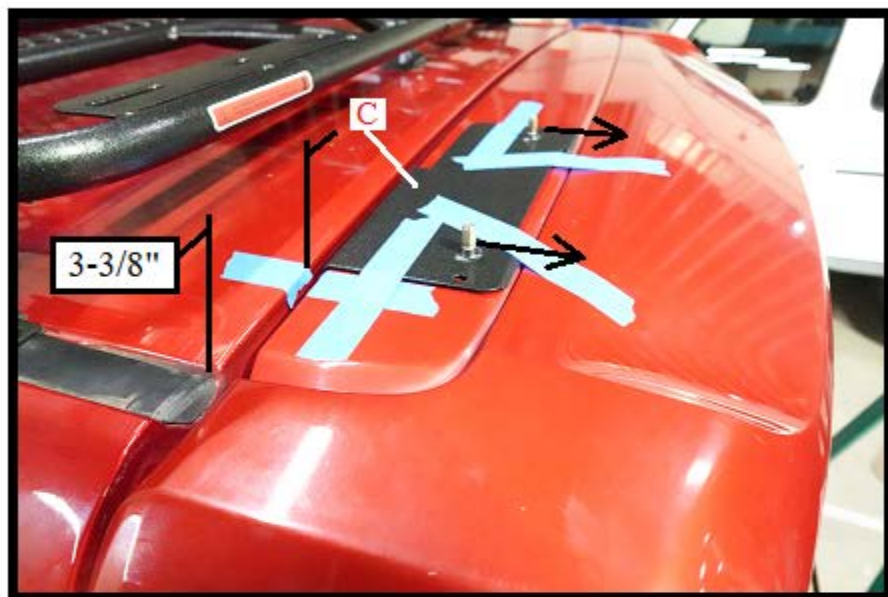
**Fig. 4**

As shown in Fig. 4, while holding pressure on hanger plate (C) in the direction of the arrows and holding hanger plate's left edge in line with masking tape marker, apply masking tape to hanger plate and the top of the rear door to hold hanger plate (C) in place temporarily.

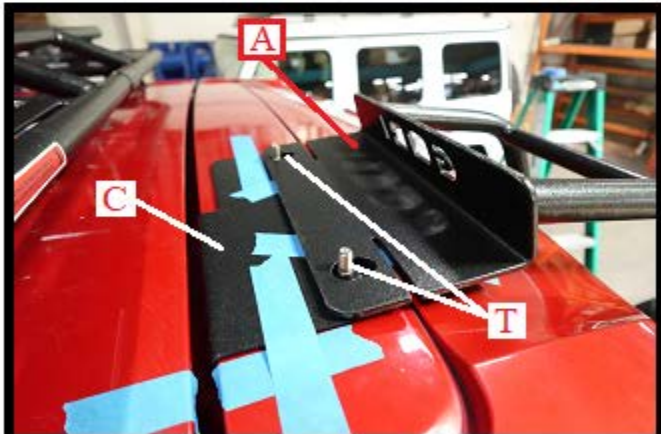
Fig. 5**Fig. 6**

As shown in Fig. 5 and Fig. 6, hang ladder (A) over hanger plate (C) threaded studs (T) and gently let the ladder rest onto the back of the rear door as shown in Fig. 7.

GOBI TOYOTA 4 RUNNER 5TH GEN REAR DRIVER SIDE LADDER INSTALLATION INSTRUCTIONS

**Fig. 7**

As shown in Fig. 7, position ladder (A) so that it rests vertically equal to the left edge of the license plate.

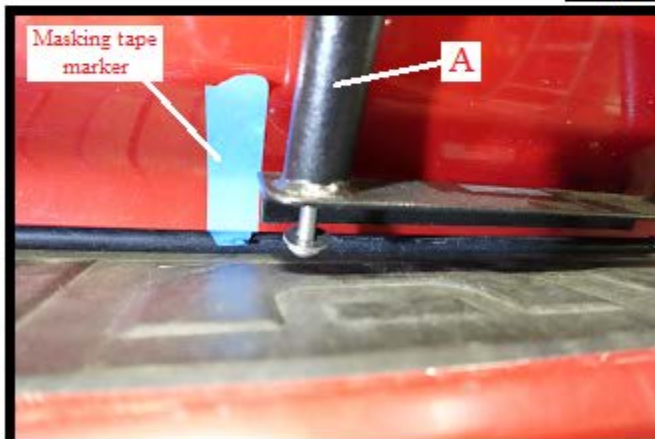
Fig. 8**Fig. 9**

As shown in Fig. 8, with ladder (A) set properly as shown in Fig. 7, place a piece of masking tape on the rear door along the lower left edge of the ladder, make certain to fold a piece of the masking tape under the door's lower edge. Note: at this time the ladder will rest approximately 1/8" to 3/16" above the lower door edge, this is normal. As shown in Fig. 9, remove rear door ladder (A).

GOBI TOYOTA 4 RUNNER 5TH GEN REAR DRIVER SIDE LADDER INSTALLATION INSTRUCTIONS

**Fig. 10**

As shown in Fig. 10, remove hanger plate (C) from the top of the door. Peel off the double back tape protective covering.

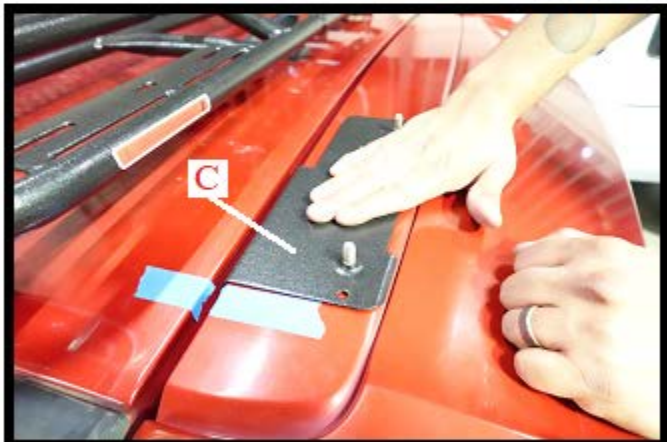
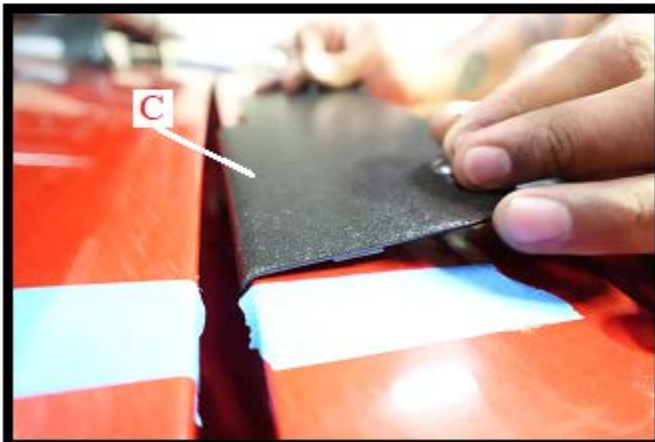
Fig. 11**Fig. 12**

As shown in Fig. 11 and Fig. 12, re-install hanger plate (C) back onto the rear door as was shown in Fig. 2 and Fig. 3. Make certain that left edge of hanger plate (C) in line with masking tape marker. After hanger plate has been installed hold pressure on hanger plate for at least 30 seconds.

GOBI TOYOTA 4 RUNNER 5TH GEN REAR DRIVER SIDE LADDER INSTALLATION INSTRUCTIONS

Fig. 13**Fig. 14**

As shown in Fig. 13 and Fig. 14, open the rear door and clean the area where the ladder was seated and the underside of the rear door with denatured alcohol.

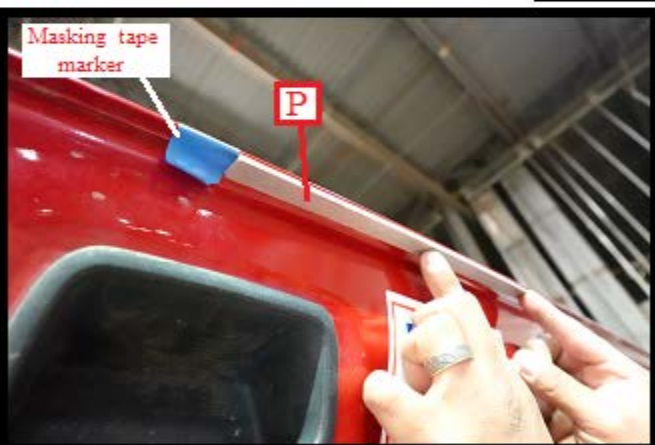
Fig. 15**Fig. 16**

As shown in Fig. 15, remove pinch plate (P) from clamp plate (B) located in your hardware kit. Peel off the protective double back tape covering. Adhere pinch plate (P) as shown in Fig. 16 to the right side of the masking tape marker and even with the lower edge of the door, then close the rear door.

GOBI TOYOTA 4 RUNNER 5TH GEN REAR DRIVER SIDE LADDER INSTALLATION INSTRUCTIONS

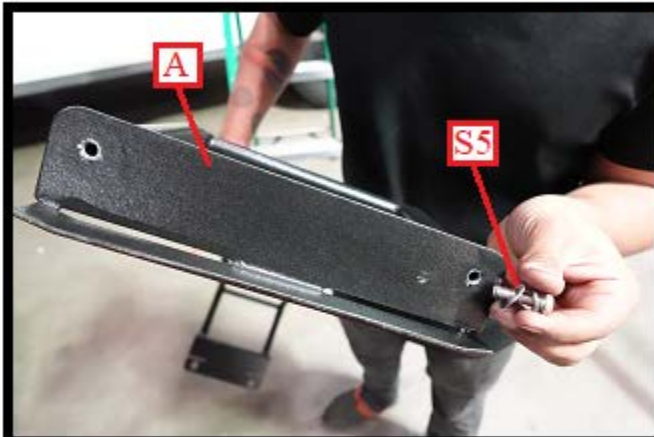
Fig. 17**Fig. 18**

As shown in Fig. 17, remove both 5/16-18 x 1" button head screws, lock washers and flat washers (S5) from the bottom of ladder (A) and hold nearby as they will be needed shortly. As shown in Fig. 18, peel off the lower ladder double back tape protective covering.

Fig. 19**Fig. 20**

As shown in Fig. 19, place ladder (A) back onto hanger plate (C) as shown in Fig. 20 but do not set onto the rear door at this time.

GOBI TOYOTA 4 RUNNER 5TH GEN REAR DRIVER SIDE LADDER INSTALLATION INSTRUCTIONS

**Fig. 21**

As shown in Fig. 21, pull down ladder (A) in the direction of the arrows with force, then align the left side edge of the ladder with the masking tape marker and align the bottom of the ladder with the bottom edge of the door. Press ladder onto the door and hold in place for 30 seconds.

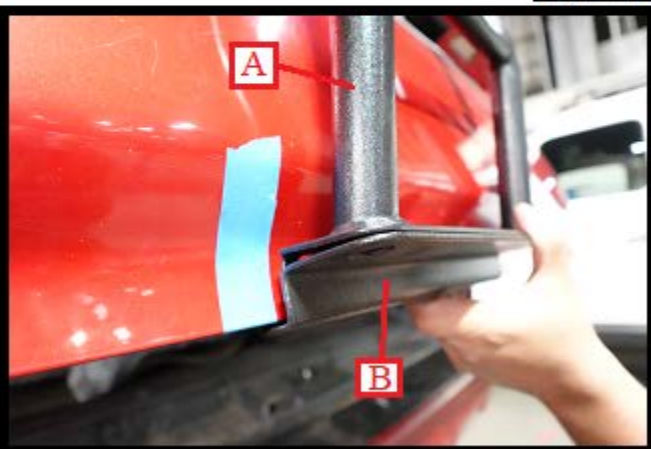
Fig. 22**Fig. 23**

As shown in Fig. 22 and Fig. 23, while still holding the ladder against the rear door, open the rear door partially. Remove lower clamp (B) from your hardware kit and install as shown in Fig. 23. The lower ladder may rise a small amount higher than the lower door's edge during this part of the installation, but this is normal. The ladder will be pulled back down when the installation has been completed.

GOBI TOYOTA 4 RUNNER 5TH GEN REAR DRIVER SIDE LADDER INSTALLATION INSTRUCTIONS

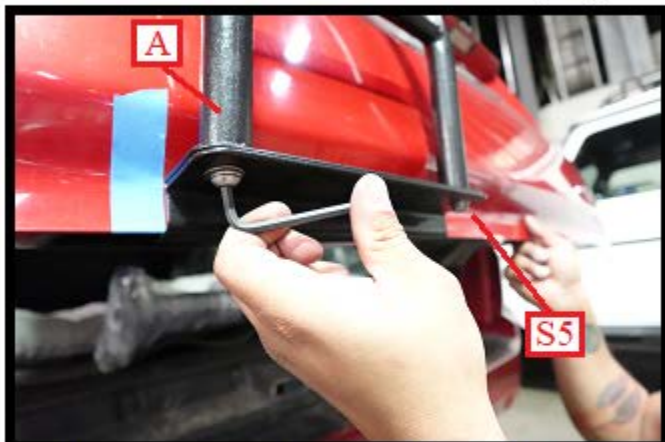
Fig. 24**Fig. 25**

As shown in Fig. 24, use the 5/16-18 x 1" button head screws, lock washers and flat washers (S5) removed earlier in Fig. 17 and re-install back up through lower clamp (B) and into lower ladder (A). As shown in Fig. 25 use the 3/16" Allen wrench supplied in your hardware kit to fully tighten both screws (S5).

**Fig. 26**

As shown in Fig. 26, lower clamp (B) has been fully tightened up against lower ladder (A).

GOBI TOYOTA 4 RUNNER 5TH GEN REAR DRIVER SIDE LADDER INSTALLATION INSTRUCTIONS

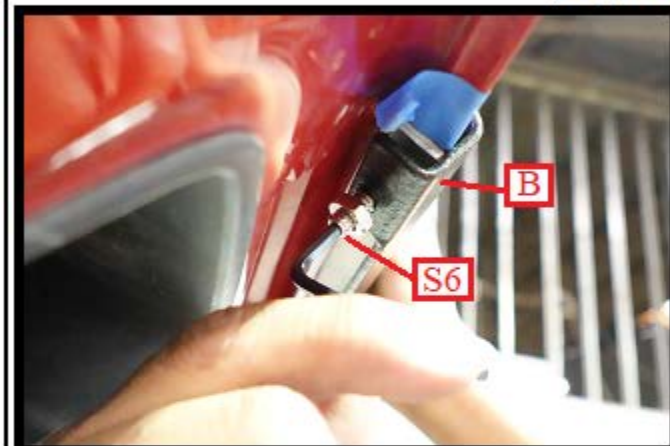
Fig. 27**Fig. 28**

As shown in Fig. 27 and Fig. 28, open the rear door halfway. Use the supplied 1/8" Allen wrench to fully tighten both inside clamp (B) set screws (S6). Do not over tighten screws.

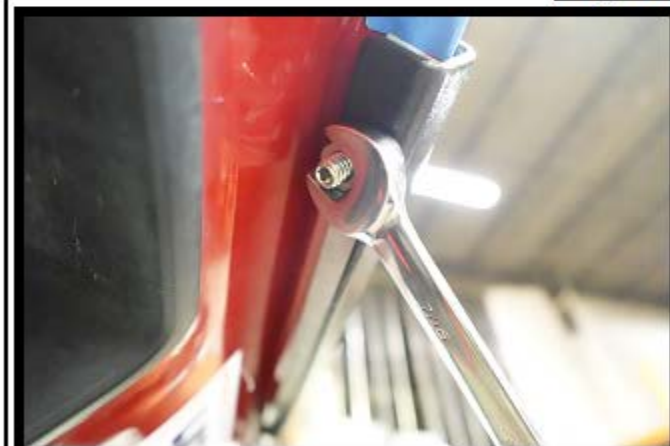
Fig. 29**Fig. 30**

As shown in Fig. 29, use a 7/16" open end wrench and fully tighten both jam nuts of screws (S6) in place. Do not over tighten. The lower clamp plate is now fully installed.

GOBI TOYOTA 4 RUNNER 5TH GEN REAR DRIVER SIDE LADDER INSTALLATION INSTRUCTIONS

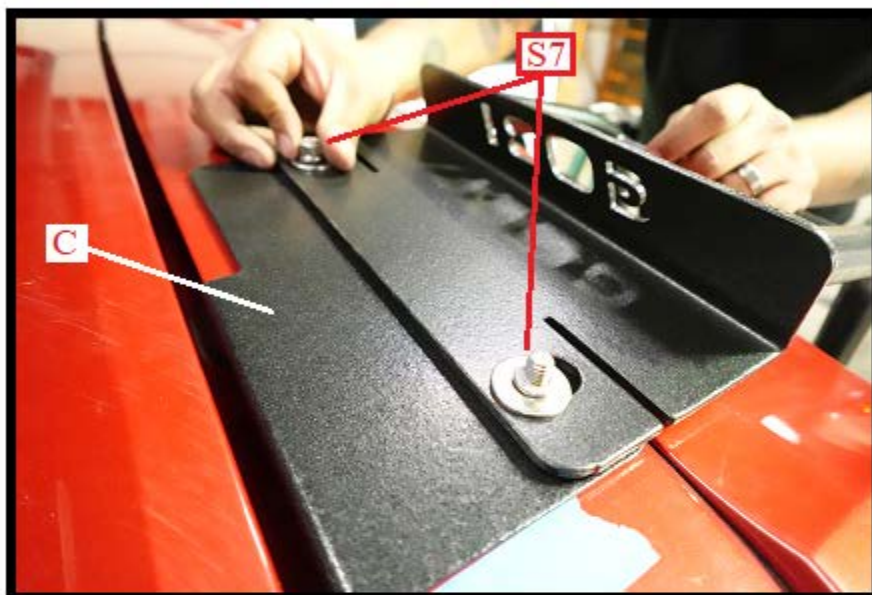
**Fig. 30**

As shown in Fig. 30, install both 5/16" flat washers, lock washers and nuts (S7) located in your hardware kit onto each hanger plate (C) threaded stud.

**Fig. 31**

As shown in Fig. 31, fully tighten both screws (S7) using a 1/2" open or closed end wrench. Do not over tighten.

GOBI TOYOTA 4 RUNNER 5TH GEN REAR DRIVER SIDE LADDER INSTALLATION INSTRUCTIONS



INSTALLATION COMPLETED