

GOBI FORD BRONCO 2 & 4 DOOR HARD & SOFT TOP ROOF RACK INSTALLATION INSTRUCTIONS

The rack must be inspected before each use to make certain attachments are secure, and for evidence of wear. Misuse of the rack or failure to observe the manufacturer's instructions as to installation, proper Attachment and maintenance will void warranties that may be implied by law.

TOOLS REQUIRED FOR INSTALLATION:

- 2- 1/2" Open and closed end wrench
- 2- 9/16" Open and closed end wrench
- 1- 9/16" socket with 3/8" drive and 10" extension
- 1- 18mm socket (for rear bumper removal)
- 1- 13mm socket (for rear bumper removal)
- 1- 10mm socket with 3/8" drive
- 1- Torx bit (T-50) (hard top removal)
- 1- Torx bit (T-25) (for front side mirror covers)
- 1- 3/16 Allen wrench
- 1- small rubber mallet
- 1- extra anti-seize lubricant
- 1- denatured alcohol

CAUTION

**USE ANTI-SEIZE LUBRICANT
ON ALL SCREWS**

NOTE: PAY SPECIAL ATTENTION TO RED HIGHLIGHTED INSTRUCTIONS

GOBI FORD BRONCO 2 & 4 DOOR HARD & SOFT TOP ROOF RACK INSTALLATION INSTRUCTIONS

Guidelines:

When using Load Carriers and Accessories, the user must understand the precautions. The points listed below will assist you in using the rack /carrier system and will encourage safety.

- For quality fits and safty, use only the recommended rack or accessory. Do not assume an accessory will fit, always check with dealer when obtaining new accessories. Use only approved accessories on load carriers. Using other brands will void your warrenty.
- Make sure all knobs, bolts, screws, straps, and locks are firmly attached, tightened and locked before every trip. Knobs, bolts, screws, straps, and locks must be periodically inspected for signs of wear, corrosion, and fatigue. Check your load at stops during the trip to insure continued fastening security.
- Check local and state laws governing projection of objects beyound the width of a vehicle. **Be aware of the width and height of your cargo since low clearance branches, bridges, and parking garages can affect the load** All cargo will affect the vehicle's driving behavior. Never drive with any lock, know, or rack in an open or unlocked position. All long loads such as, but not limited to sailboards, surfboards, kayaks, canoes, and lumber must be tied down front and rear to the bumpers or tow hooks, of the vehicle.
- Remove your rack accessories when they are not in use, before intering car washes, prior to taking in your vehicle for service, and whenever clearance may be an issue.
- All locks must be turned and moved periodically to insure smooth operation. Use graphite or similar dry lubricant to help this. Locks are designed to deter vandalism and theft. Remove valuable gear if your vehicle is unattended for an extended period. Place at least one key in the glove compartment.
- For safety to your vehicle and rack system, obey all posted speed limits and traffic cautions. Adapt your speed to the conditions of the road and the load being carried.
- Do not use load carriers and accessories for purposes other than those for which they were designed. Do not exceed their carrying capacity.
- Consult with your dealer if you have any questions regarding the operations and limits of this product. Review all instructions carefully.

READ ALL INSTRUCTIONS PRIOR TO INSTALLATION

NOTE: PAY SPECIAL ATTENTION TO RED HIGHLIGHTED INSTRUCTIONS

GOBI FORD BRONCO 2 & 4 DOOR HARD & SOFT TOP ROOF RACK

Included in kit

INSTALLATION INSTRUCTIONS

Letter	Description	Location	Quantity																				
A	GOBI FORD BRONCO 2 & 4 DOOR ROOF RACK	Main box	1																				
B	GOBI BRONCO STEALTH FRONT LIGHT BAR	Strapped to Rack	1																				
C	GOBI BRONCO REAR RACK SUPPORTS PASSENGER AND DRIVER	Strapped to Rack	1 ea.																				
D	REAR RACK SUPPORT TOWERS W/ IN & OUT BRACES PASSENGER AND DRIVER	Strapped to rack	1 ea.																				
E	REAR TOWER FRAME EXTENSION W/ EXT. PLATES E-1 PASSENGER AND DRIVER	Hardware Box	1 ea.																				
F	LIGHT BAR CLAMP, COVER PLATE, NUT PLATE, WEAR PLATE PASS & DRIVER	BAG #2	1 ea.																				
G	<p>GOBI RACK MOUNTING HARDWARE</p> <p><u>CONTENTS:</u></p> <table border="0"> <tr> <td>4- Black nylon bushings</td> <td>10- 5/16-18 x 3/4" Carriage screws</td> </tr> <tr> <td>4- 1/2" Flat washer</td> <td>6- 5/16" Lock washers</td> </tr> <tr> <td>2- 1/2-13 x 2-1/2" hex head screw</td> <td>14- 5/16" Flat washers</td> </tr> <tr> <td>2- 1/2" Nylock nut</td> <td>2- 5/16" Flat fender washers</td> </tr> <tr> <td>12- 3/8-16 x 1-1/4" hex head screw</td> <td>6- 5/16-18 x 1" Button head screws</td> </tr> <tr> <td>42- 3/8" Flat washer</td> <td>10- 5/16" Nylock nuts</td> </tr> <tr> <td>28- 3/8" Nylock nut</td> <td>4- 3/8-16 x 4-1/2" Carriage bolts</td> </tr> <tr> <td>6- 3/8-16 x 1-1/4" Carriage screws</td> <td>2- 1/4" Flat washer (light bar foot plate)</td> </tr> <tr> <td>4- 3/8-16 x 1" Carriage screws</td> <td>4- Rear support bar position plate</td> </tr> <tr> <td>2- 3/8-16 x 1" Head head screw</td> <td>1- Package of Anti-Seize lubricant</td> </tr> </table>	4- Black nylon bushings	10- 5/16-18 x 3/4" Carriage screws	4- 1/2" Flat washer	6- 5/16" Lock washers	2- 1/2-13 x 2-1/2" hex head screw	14- 5/16" Flat washers	2- 1/2" Nylock nut	2- 5/16" Flat fender washers	12- 3/8-16 x 1-1/4" hex head screw	6- 5/16-18 x 1" Button head screws	42- 3/8" Flat washer	10- 5/16" Nylock nuts	28- 3/8" Nylock nut	4- 3/8-16 x 4-1/2" Carriage bolts	6- 3/8-16 x 1-1/4" Carriage screws	2- 1/4" Flat washer (light bar foot plate)	4- 3/8-16 x 1" Carriage screws	4- Rear support bar position plate	2- 3/8-16 x 1" Head head screw	1- Package of Anti-Seize lubricant	BAG #3 Hardware Box	1
4- Black nylon bushings	10- 5/16-18 x 3/4" Carriage screws																						
4- 1/2" Flat washer	6- 5/16" Lock washers																						
2- 1/2-13 x 2-1/2" hex head screw	14- 5/16" Flat washers																						
2- 1/2" Nylock nut	2- 5/16" Flat fender washers																						
12- 3/8-16 x 1-1/4" hex head screw	6- 5/16-18 x 1" Button head screws																						
42- 3/8" Flat washer	10- 5/16" Nylock nuts																						
28- 3/8" Nylock nut	4- 3/8-16 x 4-1/2" Carriage bolts																						
6- 3/8-16 x 1-1/4" Carriage screws	2- 1/4" Flat washer (light bar foot plate)																						
4- 3/8-16 x 1" Carriage screws	4- Rear support bar position plate																						
2- 3/8-16 x 1" Head head screw	1- Package of Anti-Seize lubricant																						
H	<p>GOBI VEHICLE BODY WEAR PLATES</p> <p><u>CONTENTS:</u></p> <table border="0"> <tr> <td>2- Black, rectangular adhesive backed light bar wear plates, passenger & driver</td> <td></td> </tr> <tr> <td>2- Black, hardtop upper rear isolator adhesive backed wear plate passenger and driver</td> <td></td> </tr> <tr> <td>2- Clear wear tape 2" x 7" with white backing</td> <td></td> </tr> </table>	2- Black, rectangular adhesive backed light bar wear plates, passenger & driver		2- Black, hardtop upper rear isolator adhesive backed wear plate passenger and driver		2- Clear wear tape 2" x 7" with white backing		BAG #4 Hardware Box	1														
2- Black, rectangular adhesive backed light bar wear plates, passenger & driver																							
2- Black, hardtop upper rear isolator adhesive backed wear plate passenger and driver																							
2- Clear wear tape 2" x 7" with white backing																							
I	Black rear fender isolator wear plate pass & driver (4- M8 x 25mm SS button head screws & 4- 5/16" SS flat washers supplied for soft top only)	Hardware Box	1 ea.																				
J	WINDSHIELD ACCESSORY LIGHT BAR SUPPORT BRACKETS PASS & DRIVER	BAG #5	1 ea.																				
K	GOBI MINI WIND DEFLECTORS (complete with all mounting hardware)	Hardware Box	1 ea.																				

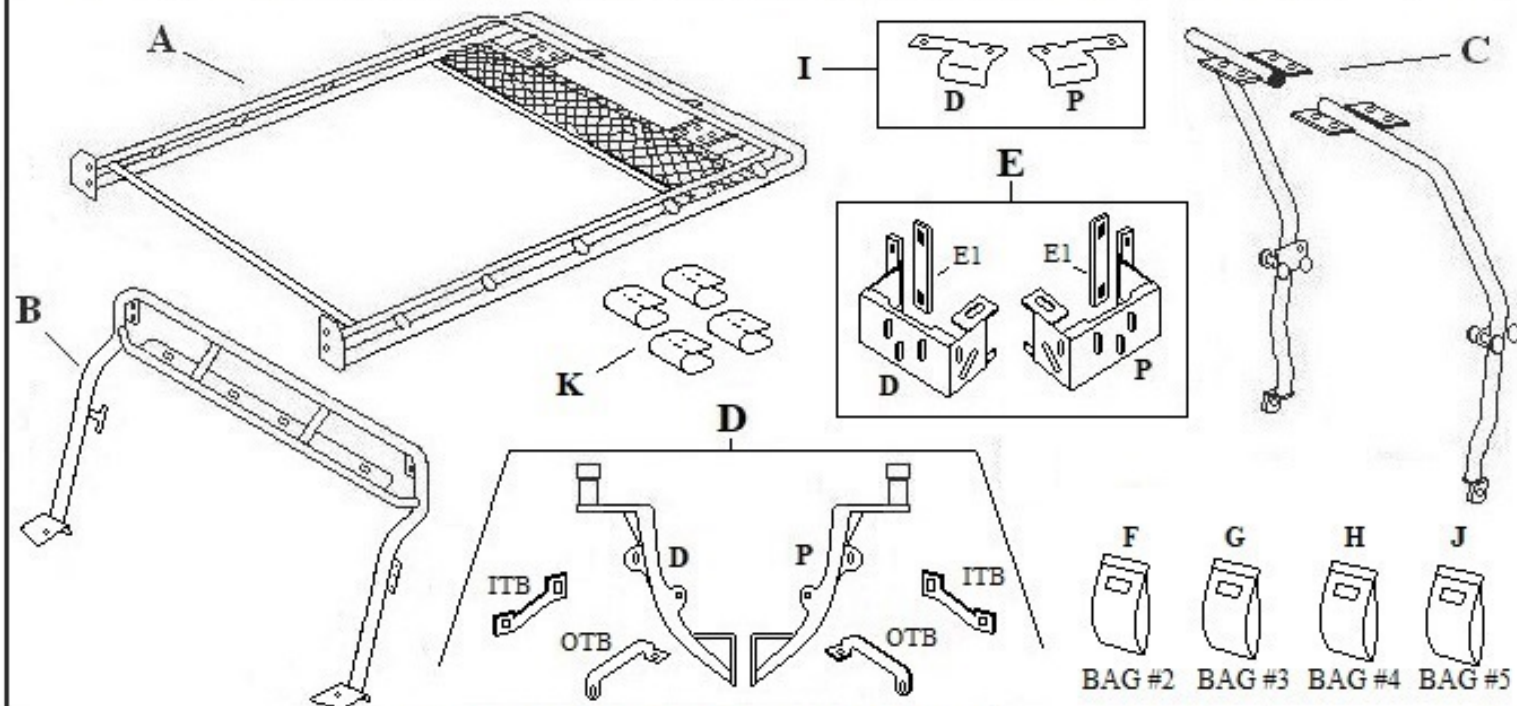

GOBI FORD BRONCO 2 & 4 DOOR HARD & SOFT TOP ROOF RACK INSTALLATION INSTRUCTIONS

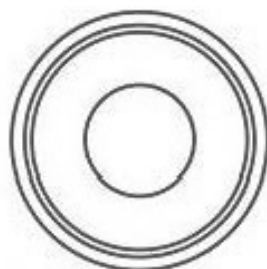
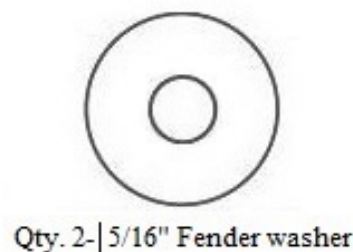
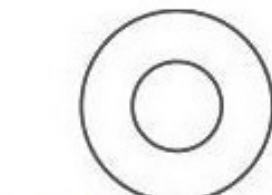
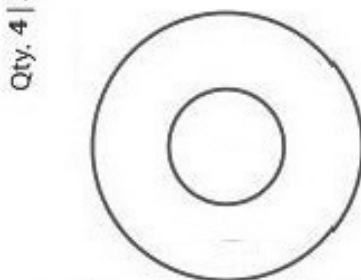
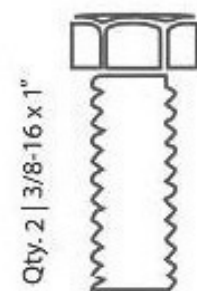
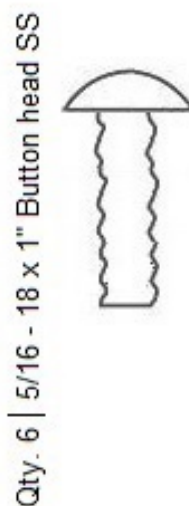
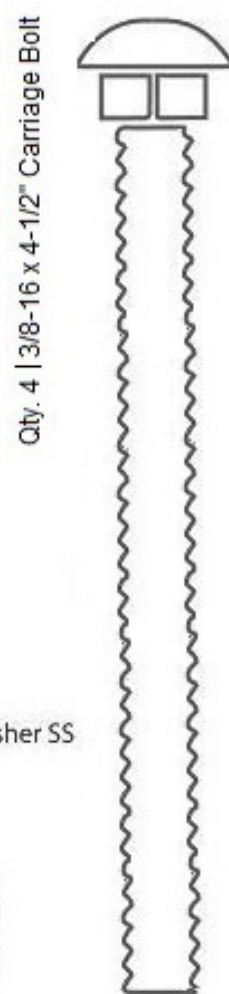
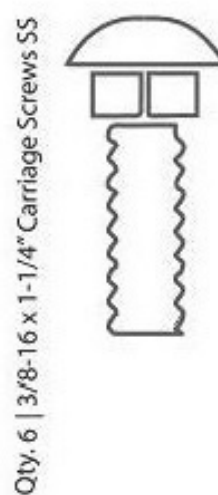
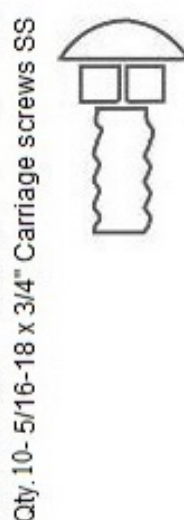
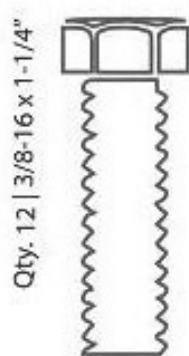
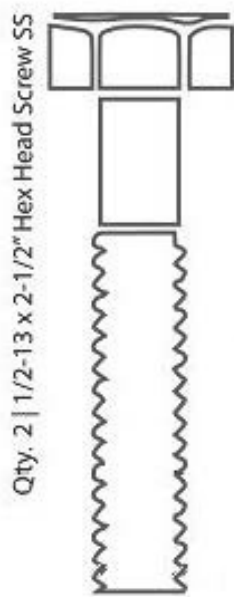

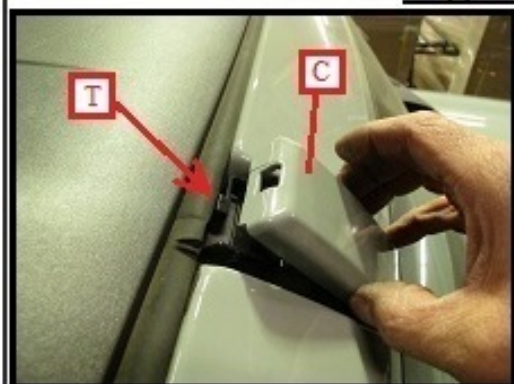
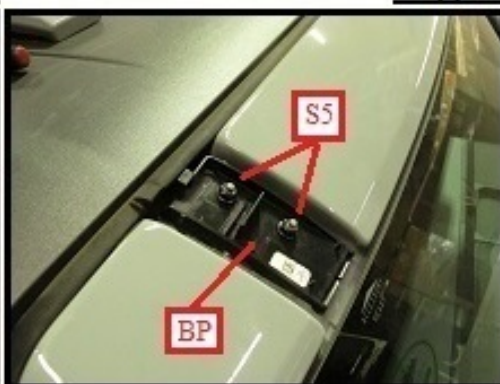
**GOBI FORD BRONCO 2 & 4 DOOR HARD & SOFT TOP ROOF RACK
INSTALLATION INSTRUCTIONS****Fig. 1****Fig. 2****Fig. 3**

As shown in Fig. 1, use a thin bladed screwdriver and push in on black tab (T) to release and lift the passenger side cover plate (C). As shown in Fig. 2 use a 10mm wrench and remove both hex head nuts (S5), then remove plastic base plate (BP) as shown in Fig. 3.

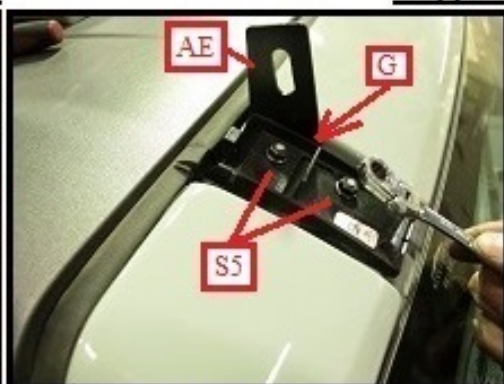
Fig. 4**Fig. 5****Fig. 6**

As shown in Fig. 4, remove the passenger side accessory extension plate (AE) from Bag #5 of your hardware kit. Orient plate (AE) as shown in Fig. 5 over the passenger side two M6 threaded studs. Place base plate (BP) over accessory plate (AE) as shown in Fig. 5 & 6. Thread nuts (S5) back in place over base plate (BP) and accessory plate (AE). Spread the gap between the two parts shown as (G) as much as possible while fully tightening down both nuts (S5), do not over tighten to warp or crack plastic base plate (BP).

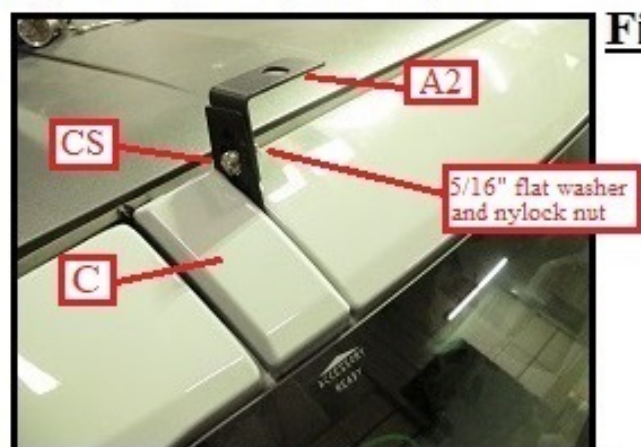
Fig. 7**Fig. 8**

As shown in Fig. 7 and Fig. 8, snap cover plate (C) back in place over base plate (BP). Remove from Bag #5 secondary extension plate (A2) and install as shown in Fig. 8. Place one 5/16-18 x 3/4" carriage screw (CS) located in Bag #3, into accessory plate (AE) then into plate (A2) as shown in Fig. 8. Thread from the other side one 5/16" flat washer and one 5/16" nylock nut and snug screws down in place. Adjust plate (A2) all the way down. Leave some play for later adjustment. Apply the same procedure to the opposite side.

**GOBI FORD BRONCO 2 & 4 DOOR HARD & SOFT TOP ROOF RACK
INSTALLATION INSTRUCTIONS****Fig. 9****Fig. 10**

As shown in Fig. 9 remove the AM/FM antenna shown by a red arrow. Then use a #T25 torx wrench and remove the outside top screw (1) holding the driver side mirror plastic cover (B1) in place. Apply the same procedure to the passenger side. As shown in Fig.10, clean off both the driver and passenger side "A" pillar top to bottom using denatured alcohol.

Fig. 11**Fig. 12**

As shown in Fig. 11 and Fig. 12, with the help of a friend, place the Gobi Bronco light bar (B) in place onto the lower windshield "A" pillar and onto the driver side mirror cover (B1). Make certain to seat the lower light bar foot (B2) as shown in Fig. 12 over the driver side mirror cover (B1) first. Then with a friend pulling the passenger side of light bar (B) out, shown in Fig. 11 by a red arrow. Slip the passenger side foot (B2) over the passenger side "A" pillar and onto the passenger side mirror (B1) plastic cover.

**GOBI FORD BRONCO 2 & 4 DOOR HARD & SOFT TOP ROOF RACK
INSTALLATION INSTRUCTIONS****Fig. 13****Fig. 14**

Use a flat 1/4" washer (O) found in Bag #3 of your hardware kit and place under the M6 torx screw (1) removed earlier from plastic mirror cover (B1). As shown in Fig. 13, reinstall M6 Torx screw with 1/4" flat washer (O) through Gobi light bar foot plate (B2) both driver and passenger. Thread screw in place but leave loose at this time. As shown in Fig. 14 remove wear plate (B5) from Bag #4 of your hardware kit. Do not remove the double back tape adhesive cover at this time. Gently lift the upper end of light bar (B) away from the "A" Pillar as shown by the red arrow in Fig. 14. Slide wear plate (B5) as shown in Fig. 14 and Fig. 15 under light bar upper presser foot (B6).

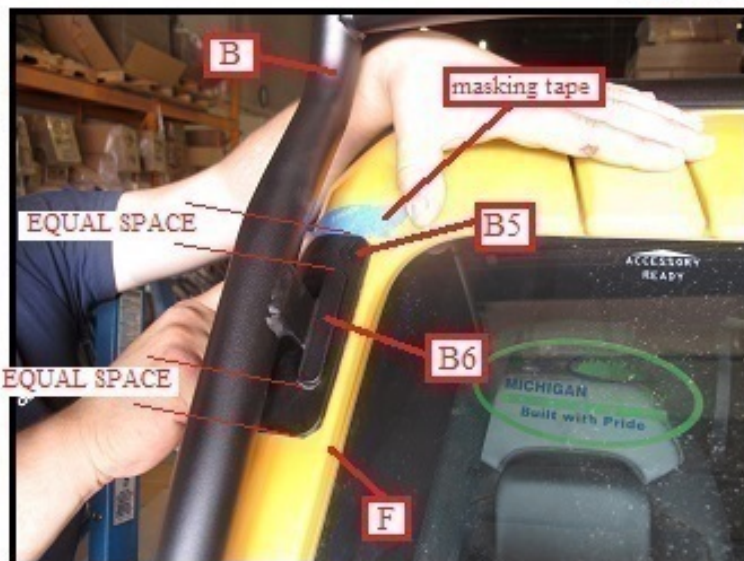
Fig. 15**Fig. 16**

As shown in Fig. 15 align wear plate (B5) close to the edge of the windshield frame (F) and equal the amount of plate on both ends of pressure foot (B6) as shown. Once you have wear plate (B5) set in place, apply a piece of masking tape to mark the top of the wear plates position. Remove wear plate (B5) and the adhesive back cover as shown in Fig. 16 and reinstall by lifting light bar (B) and installing wear plate (B5) back in place. Press down firmly and apply the same procedure to the passenger side.

**GOBI FORD BRONCO 2 & 4 DOOR HARD & SOFT TOP ROOF RACK
INSTALLATION INSTRUCTIONS****Fig.17****Fig. 18**

As shown in Fig.17 use a #25 Torx drive and tighten down screw (1) to secure Gobi Bronco light bar foot plate in place, both driver and passenger sides. Figure 18 shows the correct light bar (B) position. Remove masking tape markers.

Fig. 19**Fig. 20**

As shown by the red arrows in Fig. 19, clean off the surface area of the "A" pillar with denatured alcohol. Then remove wear plate (WP) from Bag #2 of your hardware kit. Peel off the protective covering as shown in Fig. 19 and adhere in place as shown in Fig. 20 over the corner of the "A" pillar and in line with window upper seal (SL).

**GOBI FORD BRONCO 2 & 4 DOOR HARD & SOFT TOP ROOF RACK
INSTALLATION INSTRUCTIONS****Fig. 21****Fig. 22**

As shown in Fig. 21 remove nut plate (N) from Bag #2 of your hardware kit. Slip nut plate (N) behind flange (F) and align with flange (F) holes as shown in Fig. 22 and hold in place. Remove from Bag #2 clamp plate (CP) and place over flange (F) and wear plate (WP) as shown in Fig. 22 and Fig. 23, align holes and hold in place.

Fig. 23**Fig. 24**

With the help of a friend, remove cover plate (CV) from Bag #2 and place over clamp plate (CP) as shown in Fig. 23. Remove one 5/16-18 x 1" button head screw, one 5/16" lock washer and one 5/16" flat washer from Bag #3 and thread hardware assembly (S) as shown in Fig. 24 through plates (CV) and (CP) and finally into nut plate (N). Leave loose at this time. Add two additional screw assemblies (S) into both remaining holes and into nut plate (N). Leave entire assembly loose at this time. Apply the same procedure to the opposite side.

**GOBI FORD BRONCO 2 & 4 DOOR HARD & SOFT TOP ROOF RACK
INSTALLATION INSTRUCTIONS****Fig. 25****Fig. 26**

Figure 25 shows how both the driver and passenger side clamp assembly part stack must appear. Nut plate (N), flange (F), wear plate (WP), clamp plate (CP) and cover plate (CV) in proper order and loosely held in place by three 5/16-18 x 1" button head screws, lock washers and flat washers (S). As shown in Fig. 26 by red arrows, squeeze very tightly by hand the driver side clamp plate (CP) against the "A" pillar and pull down on upper light bar tube at the same time. While continuing to hold pressure, have a friend keep cover plate (CV) straight with clamp plate (CP) and fully tighten and secure all three 5/16" button head screws (S) using the 3/16" Allen wrench supplied in Bag #3. Apply the same procedure to the opposite side.

Fig. 27**Fig. 27a**

As shown in Fig. 27, remove one 3/8-16 x 1" hex head screw and one 3/8" flat washer (W) from Bag #3 and thread down through light bar mounting plate (P) and through accessory light bar support bracket (A2). Thread from the underside as shown in Fig. 27a, one 3/8" flat washer and nylock nut (W1). Loosen screw (CS) using a 1/2" box end wrench just enough to allow bracket (A2) to slide. Then fully tighten screws (W) and (W1) and fully tighten screw (CS). Apply the same procedure to the opposite side. Reinstall AM/FM antenna. With force try to move light bar (B) as shown in Fig. 18 forward and backward and side to side to check that no play exists. If light bar does not move, the Gobi light bar installation is completed. If play exists repeat steps in Fig. 17 and 26 thru 27a.

**GOBI FORD BRONCO 2 & 4 DOOR HARD & SOFT TOP ROOF RACK
INSTALLATION INSTRUCTIONS****Fig. 28****Fig. 29****Fig. 30**

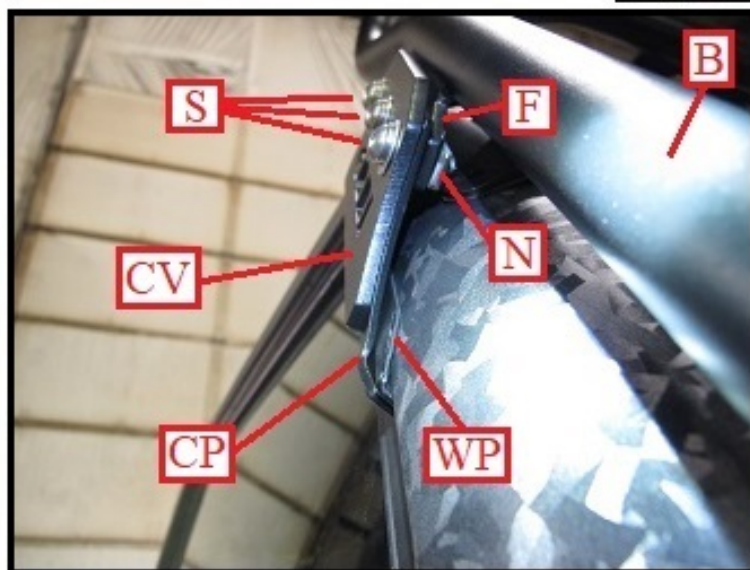
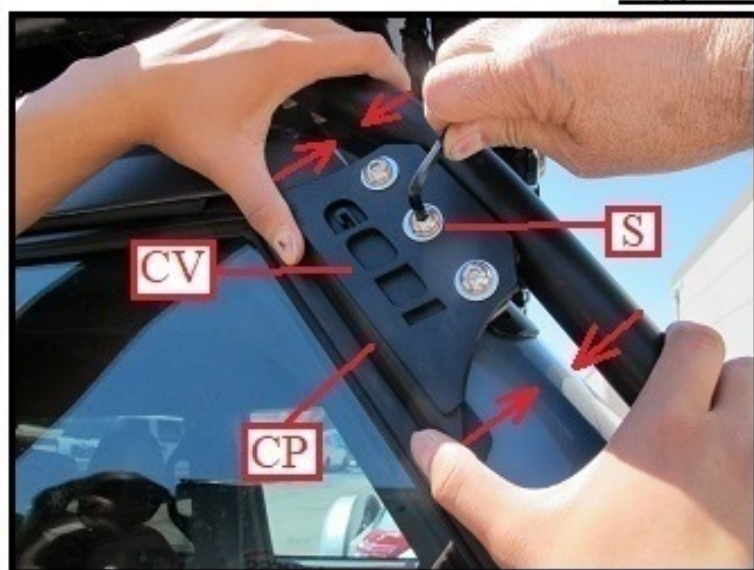
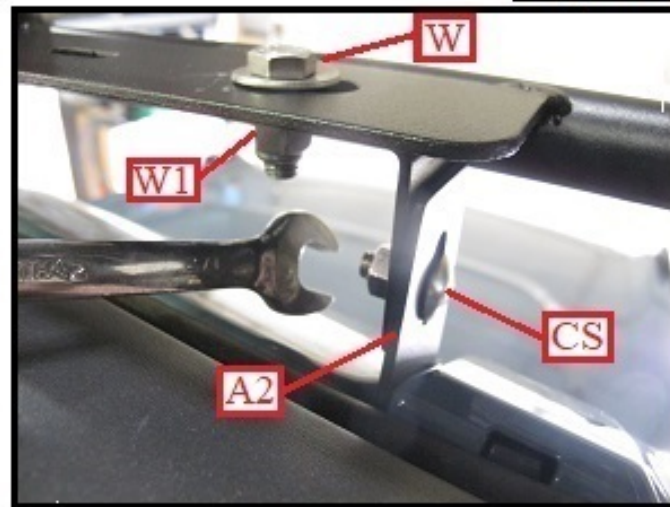
Remove both hard top front panels driver and passenger as shown in Fig. 28. Then unlock and move center main roof top panel forward as shown in Fig. 28. Remove rear hardtop screws (S) just under the rear back corners of the center panel using a "T" 50 Torx wrench, as shown in Fig. 29 both passenger and driver sides. Finally remove all interior hard top screws (SI), 4 per side as shown in Fig. 30 using a "T" 50 Torx wrench. **Disregard Fig. 28 thru 31 if you have a soft top.**

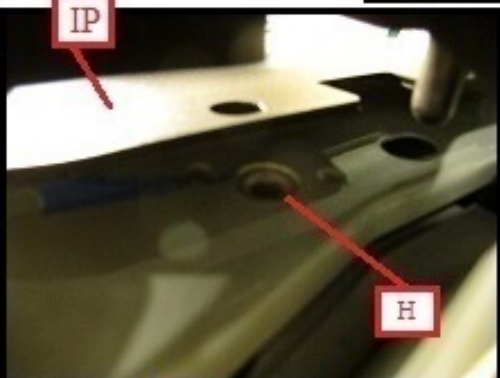
Fig. 31**Fig. 32****Fig. 33**

As shown in Fig. 31 lift and prop up the rear end of the hard top using a 2-1/2" spacer of cardboard or the like, both driver and passenger at the same time. **If you have a soft top lift up rear soft top and prop up using the prop rod to hold in place.** Remove the driver side isolator wear plate (IP) shown in Fig. 32 from your hardware kit. As shown in Fig. 32, Fig. 33 and 34, place isolator plate (IP) over screw holes (H) and onto vehicle body.

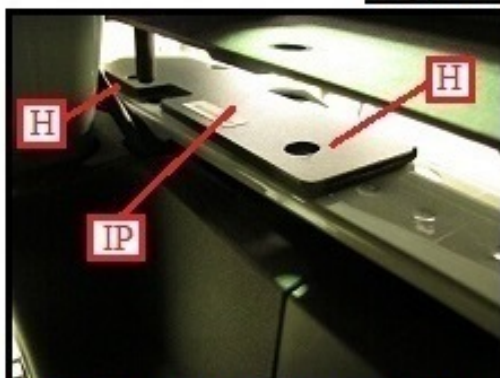
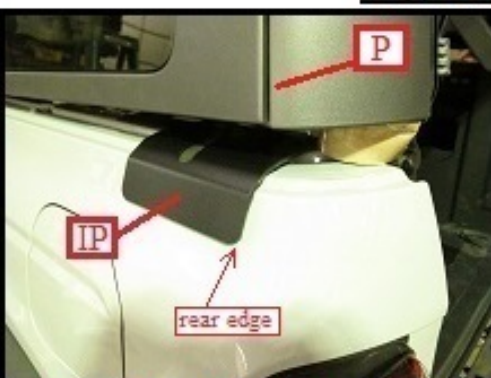
Fig. 34**Fig. 35****Fig. 36**

After the driver side isolator wear plate (IP) is set in place over screw holes (H). Make certain the rear edge of plate (IP) is in line with the hardtop rear parting line (P) as shown in Fig. 35, then apply the same procedure to the passenger side. **Alignment to parting line (P) does not apply to soft tops.** As shown in Fig. 36 take two pieces of masking tape and outline two sides of the isolator plate, approximately 1/8" to 1/4" from the edges. Remove the isolator plate (IP) and clean the surface with denatured alcohol. Remove from Bag #4 one piece of clear wear tape 2" x 7". Peel off the white protective film and adhere the clear wear tape in place within the masking tape lines to protect the paint against rubbing wear. Reinstall isolator plate as shown in Fig. 34 and 35 and apply the same procedure to the opposite side then remove the masking tape edge markers.

**GOBI FORD BRONCO 2 & 4 DOOR HARD & SOFT TOP ROOF RACK
INSTALLATION INSTRUCTIONS****Fig. 37****Fig. 38**

Make certain the driver and passenger side isolator plates (IP) are still tight up against the body as shown in Fig. 37 and lower hard top down onto isolator plates (IP). Reinstall all screws removed earlier in Fig. 29 thru 30 and fully tighten in place as shown in Fig.38. For soft tops, isolator mounting screws are supplied with isolator plates, use these screws and washers to mount the isolator plates in place tight up against the vehicle body at this time. Then drop rear soft top section back down in place.

DISREGARD FIGURES 39 THRU 41 IF YOU HAVE A SOFT TOP**Fig. 39****Fig. 40****Fig. 41**

As shown in Fig. 39, remove top rear isolator plate (IP) from Bag #4 for a 4-door roof rack or (IP2) for a 2-door roof rack as shown in Fig. 41. Then place the driver side upper rear isolator plate (IP) or (IP2) within the notch of the hard top to get a feel of how the isolator plate will fit in place. Once you understand fitment, remove the upper isolator plate and clean the area of the hardtop under the isolator plate with denatured alcohol. Wait for the area to dry then remove the protective double back tape covering from the isolator plate as shown in Fig. 40. Install as shown in Fig. 39 for a 4-door and Fig. 41 for a 2-door. Hold in place for 30 seconds and apply the same procedure to the passenger side.

GOBI FORD BRONCO 2 & 4 DOOR HARD & SOFT TOP ROOF RACK INSTALLATION INSTRUCTIONS

Fig. 41

The rear bumper (RB) will need to be removed by first unplugging both driver and passenger side rear backup sensor plugs (SP) as shown in Fig. 42 and Fig. 43. Both sensors are located at the ends of the rear bumper towards the rear tire as shown in Fig. 42.

Fig. 42**Fig. 43**

As you can see in Fig. 42 just between the rear bumper and mud flap is the rear bumper back up sensor plug (SP). Figure 43 shows a closer view of the backup sensor plug (SP) which will need to be disconnected as shown in Fig. 44.

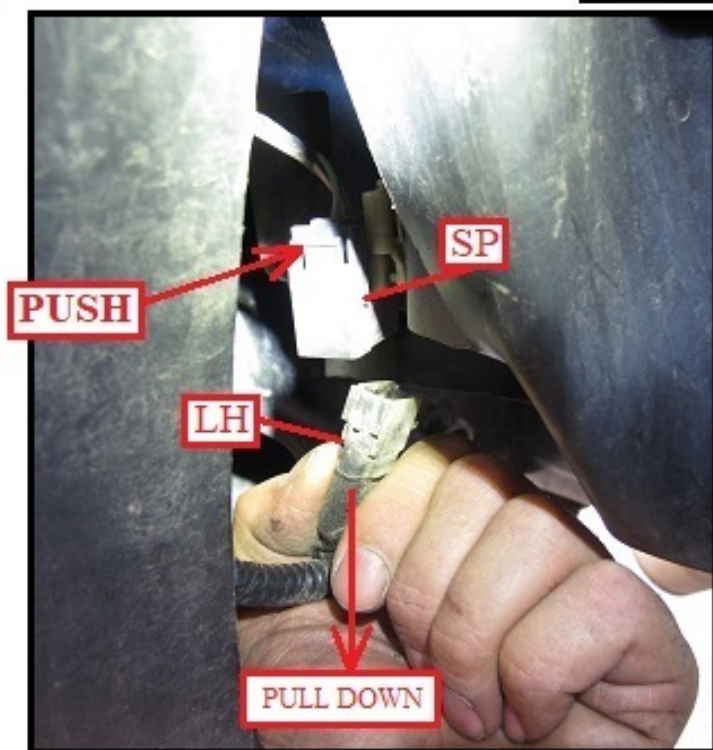
**GOBI FORD BRONCO 2 & 4 DOOR HARD & SOFT TOP ROOF RACK
INSTALLATION INSTRUCTIONS****Fig. 44**

As shown in Fig. 44 by a red arrow, push in at the top of the flat side of connector (SP) then at the same time pull down on the lower half of the connector (LH). Leave the lower half of the connector hanging freely at this time. Apply the same procedure to the opposite side. When time comes to reinstall, simply align the parts and push the lower half of connector (LH) up into the upper connector (SP). Force may need to be applied in order for the parts to lock together.

Fig. 45**Fig. 46**

As shown in Fig. 45 use a 13mm Socket and remove rear bumper end bolt (BE) and set aside for later reinstallation unless you have an aftermarket rear bumper which does not require the screw. Shown in Fig. 45 remove both Tow loop bolts (TB) using an 18mm socket and set aside for later reinstallation. As shown in Fig. 46 pull down on Tow loop with a little force to remove the Tow loop plastic push in rivet (PR) and set aside for reinstallation. Apply the same procedure to the opposite side. Open rear door and with the help of a friend and fully remove rear bumper and set aside for reinstallation.

**GOBI FORD BRONCO 2 & 4 DOOR HARD & SOFT TOP ROOF RACK
INSTALLATION INSTRUCTIONS****Fig. 47****Fig. 48**

As shown in Fig. 47 without the rear bumper in place you will see the female end of back up sensor (SP). Use a trim removal tool or the like as shown in Fig. 47 to remove sensor plug (SP) from the body. Once sensor (SP) has been removed as shown in Fig. 48, let hang freely at this time.

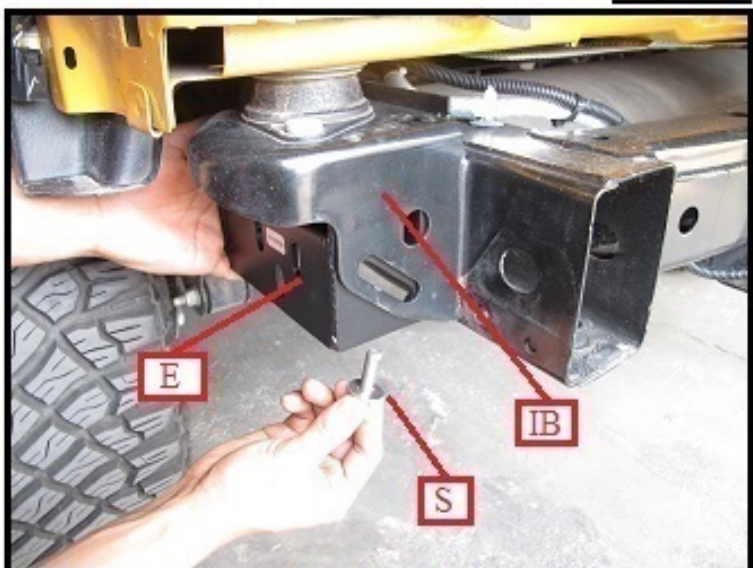
Fig. 49**Fig. 50**

Shown in Fig. 49, remove from your hardware kit, driver side frame extension (E). Then remove from frame extension (E) back plate (E1) taped to frame extension (E), shown in Fig. 53. Place back plate (E1) to the side as it will be needed shortly. As shown in Fig. 50 place frame extension (E) up into rear vehicle isolator body (IB). Then install one 3/8-16 x 1-1/4" hex head screw and 3/8" flat washer (S) up through frame extension (E) and into isolator body (IB) shown in Fig. 50 and Fig. 51.

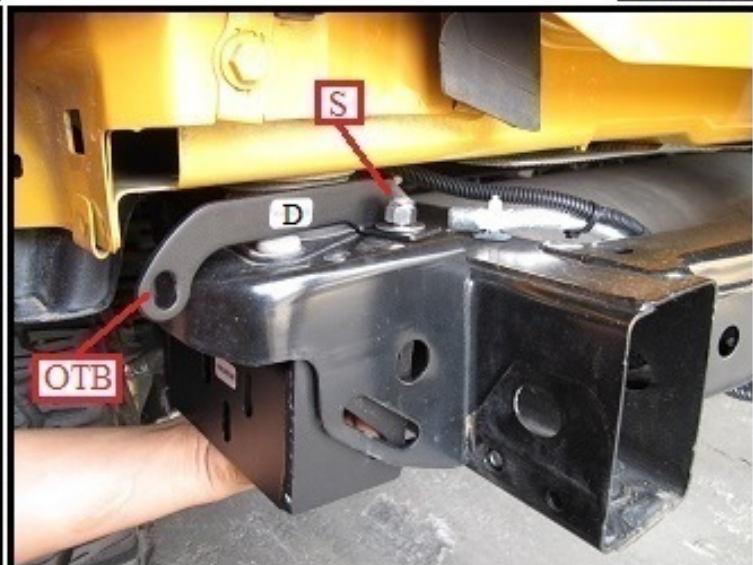
**GOBI FORD BRONCO 2 & 4 DOOR HARD & SOFT TOP ROOF RACK
INSTALLATION INSTRUCTIONS****Fig. 51****Fig. 52**

As shown in Fig. 51, remove the driver side "outside tower brace" (OTB) from package (D) of your hardware kit. As shown in Fig. 52, place brace (OTB) over the 3/8-16 x 1-1/4" hex head screw (S) just installed and thread on one 3/8" flat washer and one 3/8" nylock nut located in Bag #3 of your hardware kit. Snug down screw but leave enough play for adjustment. Remember to always add anti-seize lubricant to all screws prior to installation.

Fig. 53**Fig. 54**

As shown in Fig. 53 take frame extension back plate (E1) just recently removed from frame extension (E) and slide two 3/8-16 x 4-1/2" carriage bolts (E2) located in Bag #3, through frame extension plate (E1). As shown in Fig. 53 and Fig. 54 slide back plate (E1) and carriage bolts (E2) behind vehicle frame and into frame extension (E) shown in Fig. 55.

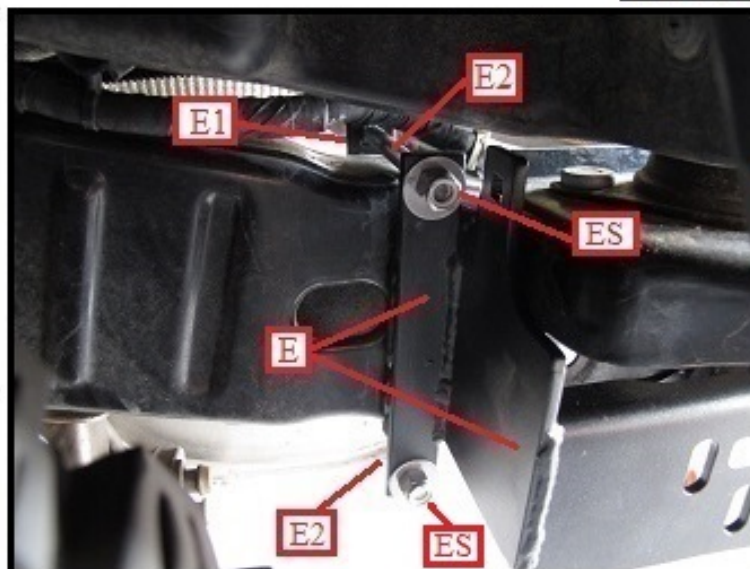
**GOBI FORD BRONCO 2 & 4 DOOR HARD & SOFT TOP ROOF RACK
INSTALLATION INSTRUCTIONS****Fig. 55****Fig. 56**

As shown in Fig. 55, after installing back plate (E1) with carriage bolts (E2) over vehicle body frame and into frame extension (E). Thread onto each carriage bolt (E2) one 3/8" flat washer and one 3/8" nylock nut (ES). Snug down in place but leave a little play for later adjustment. As shown in Fig. 56 and 57, add one 3/8-16 x 1-1/4" hex head screw and one 3/8" flat washer (S1) into the lower slot (E3) of frame extension (E). Then thread on one 3/8" flat washer and 3/8" nylock nut and snug down in place, leave just a small amount of play. As shown in Fig. 56, use a 9/16" ratchet and long extension with a 9/16" box end wrench and snug down even more screw and nut (S).

Fig. 57**Fig. 58**

As shown in Fig. 57, use a small mallet to firmly seat frame extension (E) fully against the vehicle body frame in the direction of the red arrows. Once frame extension (E) is in full contact with vehicle frame, refer to Fig. 56 and fully tighten screw (S) using a 9/16" ratchet and long extension with a 9/16" box end wrench. Then refer to Fig. 57 and fully tighten screw (S1) using two 9/16" open or closed end wrenches. Then fully tighten both screws (ES) as shown in Fig. 58.

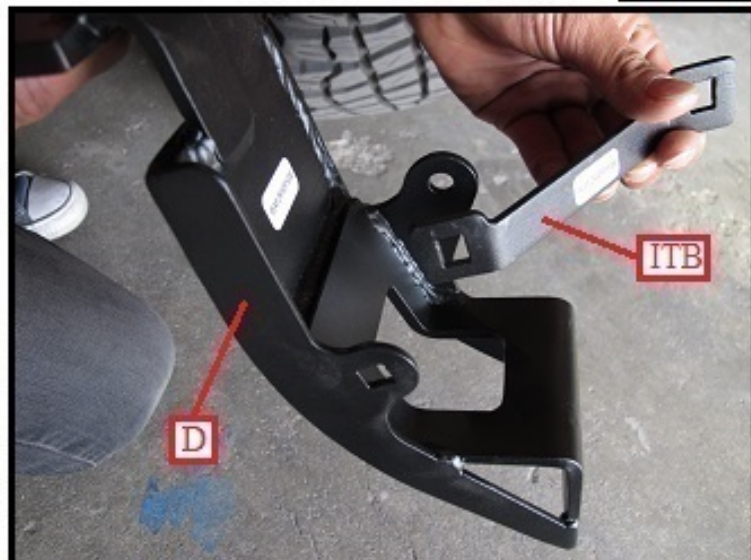
**GOBI FORD BRONCO 2 & 4 DOOR HARD & SOFT TOP ROOF RACK
INSTALLATION INSTRUCTIONS****Fig. 59****Fig. 60**

Remove from your hardware kit driver side Tower (D) as shown in Fig. 59. Also remove driver side inside tower brace (ITB) shown in Fig. 59, Fig. 60 and Fig. 61. Attach to tower as shown in Fig. 59 and 60, small end of brace (ITB) to tower using a 5/16-18 x 3/4" carriage screw (S4) located in Bag #3. As shown in Fig. 60, thread onto screw (S4) one 5/16" flat washer and one 5/16" nylock nut. Snug down in place but leave some play for adjustment.

Fig. 61**Fig. 62**

As shown in Fig. 61 by a red arrow, lift driver side brace (ITB) up and to the left side of vehicle isolator body (IB). Continue to lift and slide tower (D) in place as shown in Fig. 62 where the lower base (TB) is contacting the face of frame extension plate (E) as shown in Fig. 61 and Fig. 62.

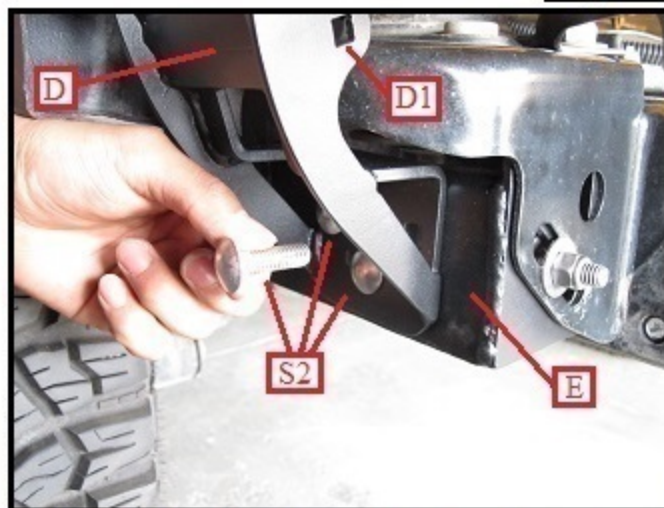
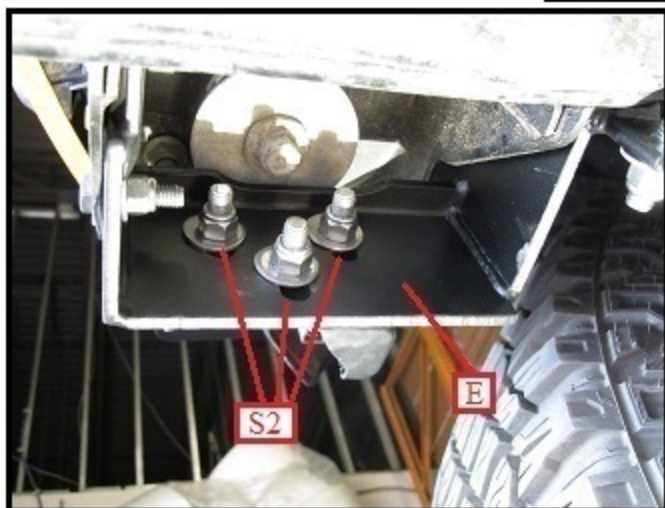
**GOBI FORD BRONCO 2 & 4 DOOR HARD & SOFT TOP ROOF RACK
INSTALLATION INSTRUCTIONS****Fig. 63****Fig. 64**

As shown in Fig. 63, slip into all 3 holes of Tower (D) and frame extension (E) three 3/8-16 x 1-1/4" carriage bolts (S2). As shown in Fig. 64 thread onto the 3 (S2) carriage bolts three 3/8" flat washers and three 3/8" nylock nuts. Snug down all three screws (S2) but leave some play for adjustment.

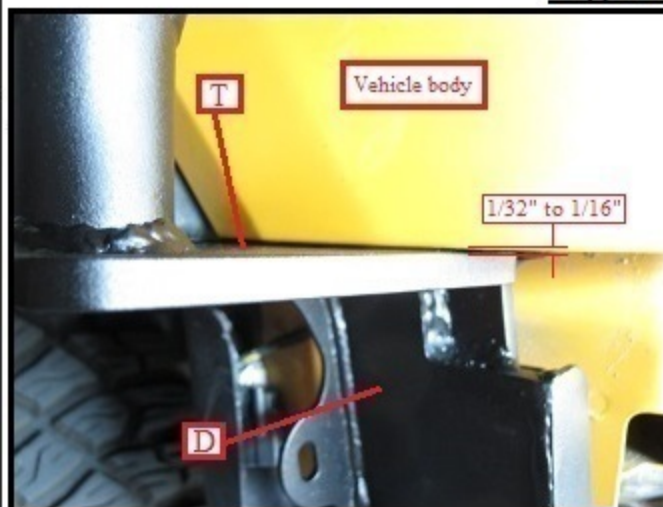
Fig. 65**Fig. 66**

As shown in Fig. 65, raise Tower (D) so that the top of the tower support plate (T) is approximately 1/32" to 1/16" below the vehicle body. As shown in Fig. 66 place a magnetic or standard small level to the side of Tower (D) and make certain Tower (D) is level, then fully tighten all 3 carriage bolt screws (S2) using a 9/16" box end wrench.

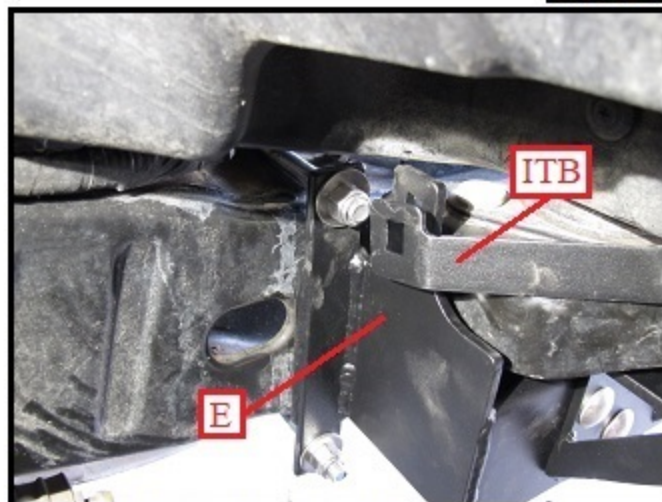
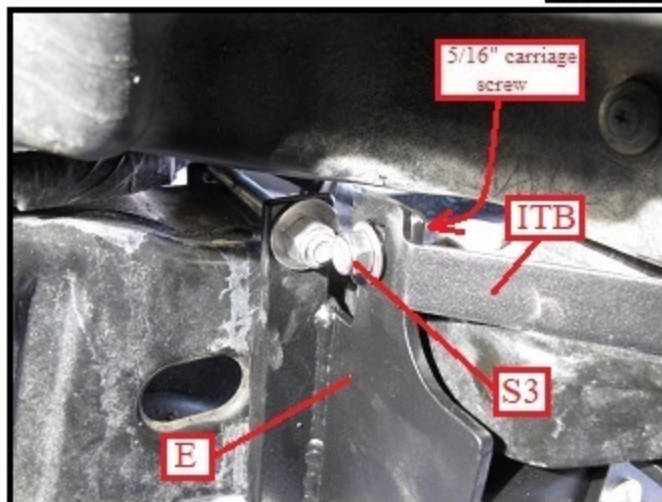
**GOBI FORD BRONCO 2 & 4 DOOR HARD & SOFT TOP ROOF RACK
INSTALLATION INSTRUCTIONS****Fig. 67****Fig. 68**

As shown in Fig. 67 and Fig. 68, line up the driver inside tower brace (ITB) to the outside of frame extension plate (E). As shown in Fig. 68 use a 5/16-18 x 3/4" carriage screw (S3) located in Bag #3 and slip through frame extension plate (E) then into inside brace (ITB) in the direction of the red arrow. Thread on one 5/16" flat washer and one 5/16" nylock nut as shown in Fig. 68 (S3) and fully tighten using a 1/2" open or closed end wrench.

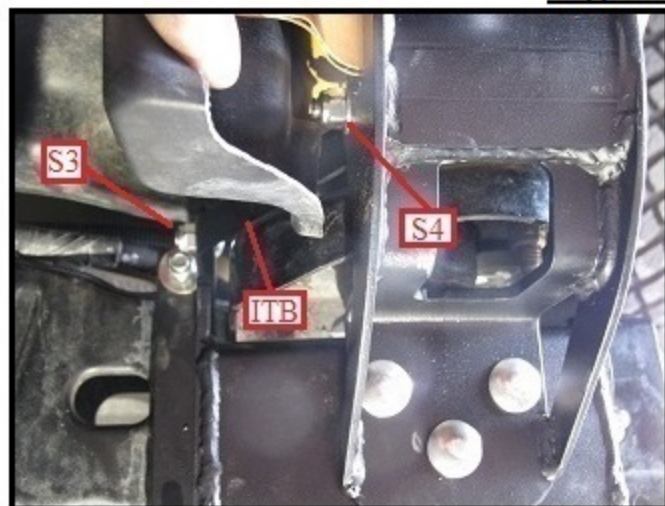
Fig. 69**Fig. 70****Fig. 71**

As shown in Fig. 69, fully tighten the second 5/16" nylock nut (S4) of the same inside brace (ITB) as shown in Fig. 68, using a 1/2" box end wrench. As shown in Fig. 70, loosen screw (S) using a 9/16" ratchet and long extension with a 9/16" box end wrench until the outside tower brace (OTB) is free to move. Then swing brace (OTB) in towards tower (D) and align free end of brace slotted hole (SH) with tower square hole (D1) as shown in Fig. 63. Slip one 5/16-18 x 3/4" carriage screw (S3) as shown in Fig. 70 by a white arrow from the inside of tower (D) out through square hole (D1) and through slotted hole at the free end of brace (OTB) as shown in Fig. 71. Add a 5/16" flat washer and 5/16" nylock nut and snug down only at this time using a 1/2" box end wrench.

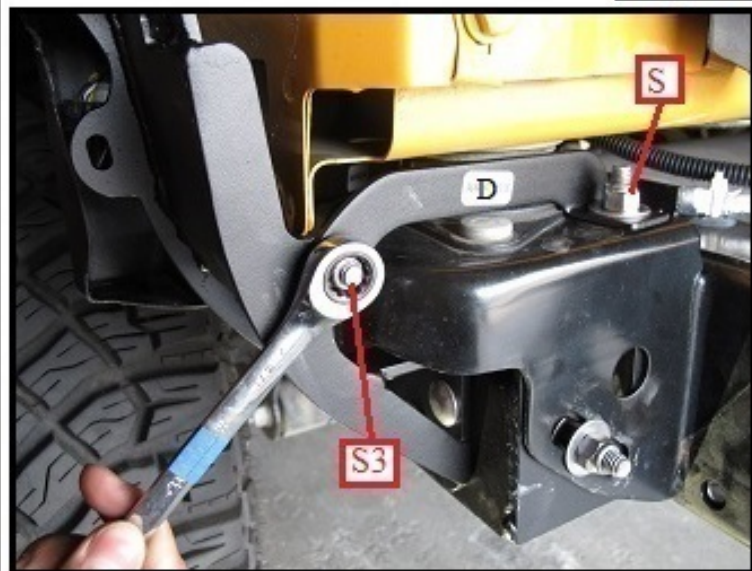
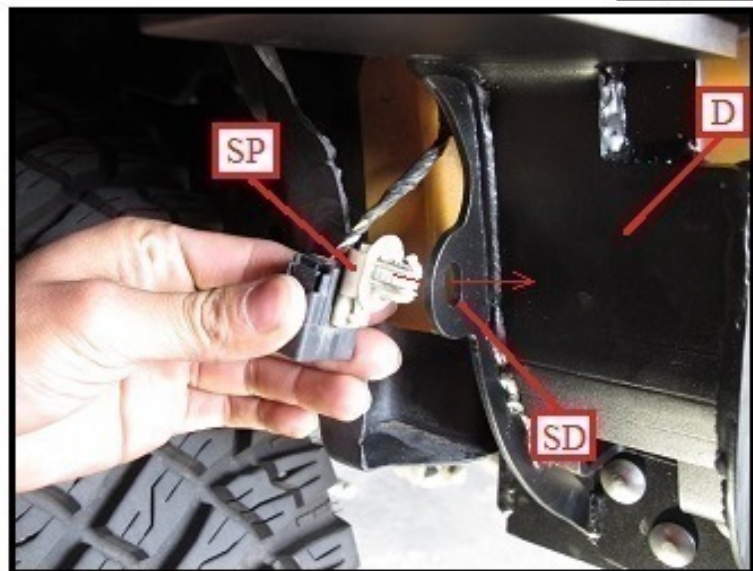
**GOBI FORD BRONCO 2 & 4 DOOR HARD & SOFT TOP ROOF RACK
INSTALLATION INSTRUCTIONS****Fig. 72****Fig. 73**

As shown in Fig.72 fully tighten down screw (S3) using a 1/2" box end wrench. Then fully tighten down screw (S) using a 9/16" socket wrench with long extension and a 9/16" closed or open end wrench. As shown in Fig. 73, take backup sensor (SP) removed earlier in Fig. 47 and push into new location (SD) on Tower (D).

Fig. 74

As shown in Fig.74 screw (S1) must be removed for the OEM rear bumper or left in place if possible, for an aftermarket rear bumper. If screw (S1) is to be left in, you must turn screw around so that the hex head of screw is facing out as shown in Fig.74 (S1). Driver side Tower (D) installation is completed. Apply the same procedure to the passenger side then reinstall rear bumper, reversing the procedure shown in Figures 44, 45 and 46.

**GOBI FORD BRONCO 2 & 4 DOOR HARD & SOFT TOP ROOF RACK
INSTALLATION INSTRUCTIONS****Fig. 75****Fig. 76**

As shown in Fig. 75 and 76, place soft foam, blankets, or the like onto vehicle roof top to protect against scratching or marring of the hardtop during roof rack installation. With the help of others, lift roof rack (A) over the vehicle as shown and hand to another person on the opposite side. Then lay the roof rack (A) flat onto the roof top just behind light bar (B).

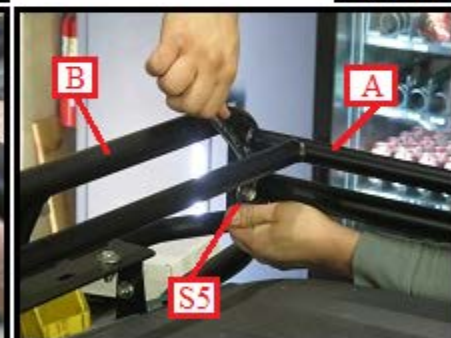
Fig. 77**Fig. 78****Fig. 79**

Remove from Bag #3 of your hardware kit four 3/8-16 x 1" carriage bolts, flat washers and nylock nuts (S5) as shown in Fig. 77 and Fig. 78. As shown in Fig. 77 and Fig. 78 connect roof rack (A) to light bar (B) by slipping the 3/8-16 x 1" carriage bolt (S5) through the front of the light bar (B) and into roof rack (A). Thread one 3/8" flat washer and nylock nut to each carriage bolt (S5) securing the roof rack to the light bar as shown in Fig. 78 and Fig. 79. Snug down screws do not fully tighten at this time. Leave a little play for latter adjustment.

**GOBI FORD BRONCO 2 & 4 DOOR HARD & SOFT TOP ROOF RACK
INSTALLATION INSTRUCTIONS****Fig. 80****Fig. 81**

As shown in Fig. 80 and Fig. 81 set two spacer blocks 2-1/2" tall under the rear of both ends of roof rack (A). Take the driver side rear support bar (C) shown in Fig. 81 and place under roof rack and let rest on roof top over protective covering. As shown in Fig. 82, align the lower end flange (C1) of rear support bar (C) with driver side rear Tower (D).

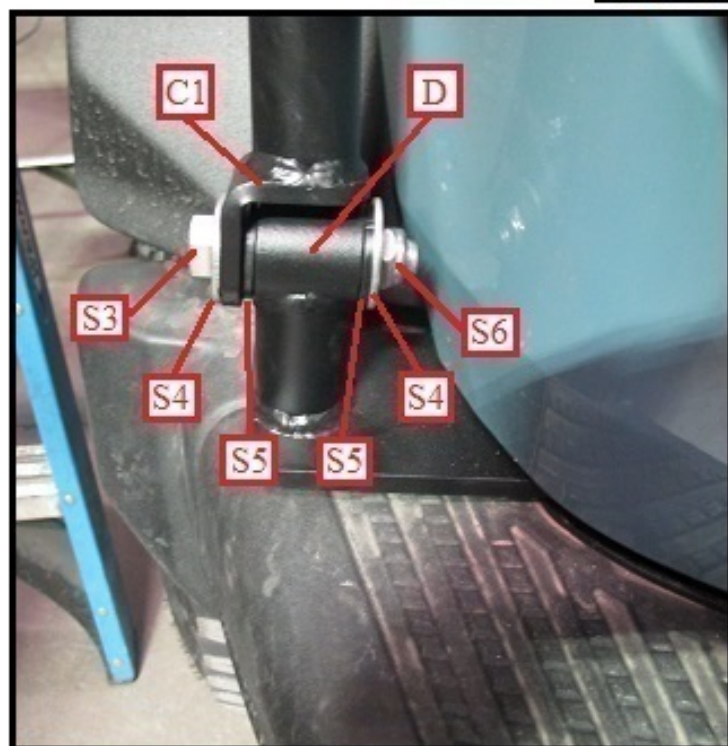
Fig. 82

Remove from Bag #3, one 1/2-13 x 2-1/2" hex bolt (S3), two 1/2" flat washers (S4), two black nylon bushings (S5) and one 1/2" nylock nut (S6). Place them in order as shown in Fig. 82 and snug down only, using a 3/4" socket ratchet and 3/4" box end wrench. Use anti-seize on all screws prior to assembly.

✦ **USE ANTI-SEIZE LUBRICANT ON ALL SCREWS** ✦

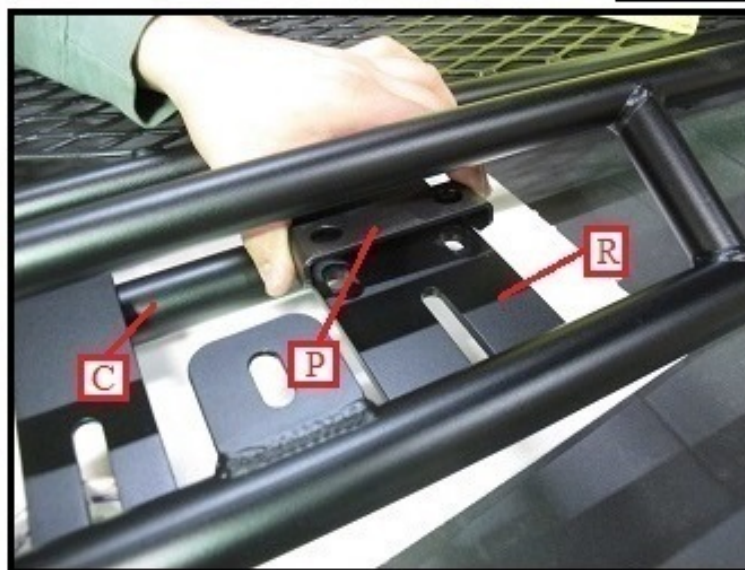
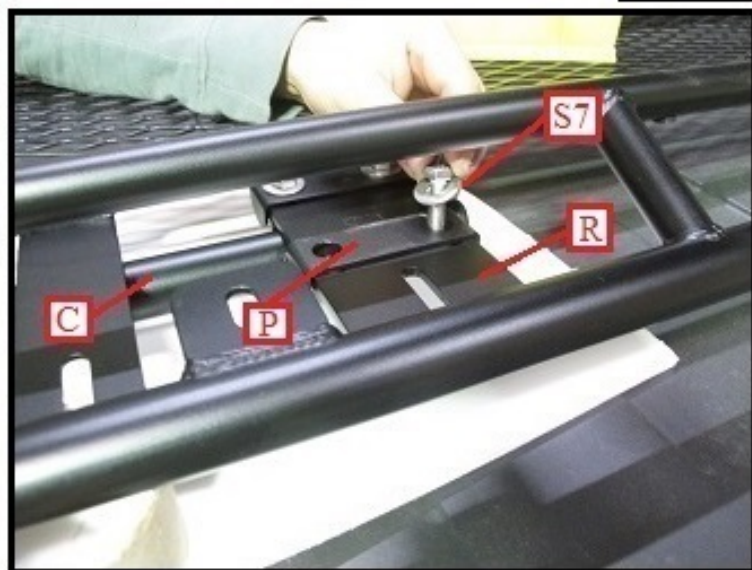
**GOBI FORD BRONCO 2 & 4 DOOR HARD & SOFT TOP ROOF RACK
INSTALLATION INSTRUCTIONS****Fig. 83****Fig. 84**

As shown in Fig. 83, remove 2 position plates (P) from Bag #3 and place over rear rack mounting plate (R) and over rear driver side support bar flange (C). Remove four 3/8-16 x 1-1/4" hex head screws, eight 3/8" flat washers and four nylock nuts (S7) from Bag #3. As shown in Fig. 84, insert four 3/8-16 x 1-1/4" hex head screws and four 3/8" flat washers (S7) through position plates (P) then through mounting plate (R) and through driver side support flange (C).

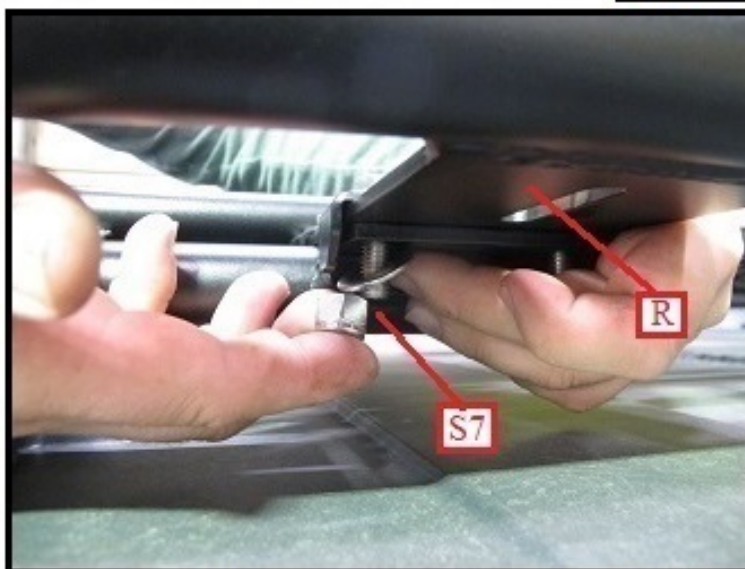
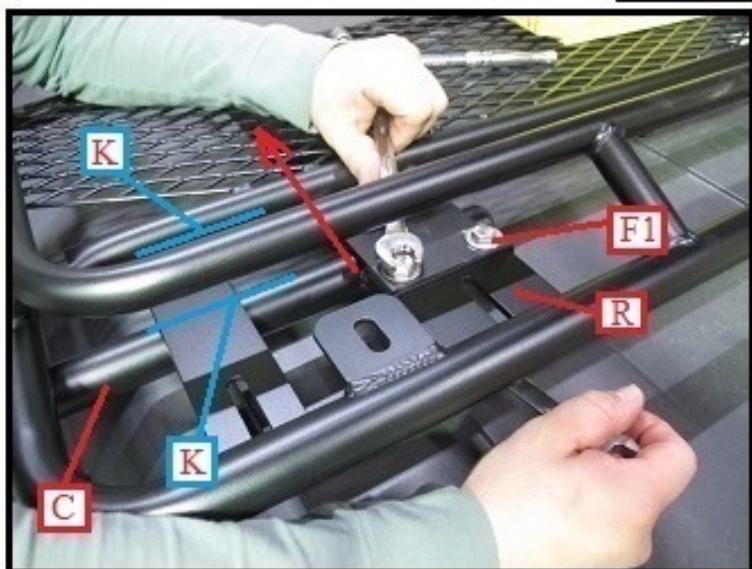
Fig. 85**Fig. 86**

As shown in Fig. 85, use four 3/8" flat washers and four 3/8" nylock nuts (S7) and snug down in place from the underside using two 9/16" box end wrenches. Do not fully tighten at this time, leave some play for adjustment. As shown in Fig. 86, adjust support bar (C) in the direction of the red arrow as far as possible in the slots of support plate (R). Then tighten mounting plate screw marked (F1) using two 9/16" box end wrenches. Adjust the rear support bar (C) by pivoting forward or rearward so that support bar (C) lines up with inner roof rack as shown by 2 blue lines (K), indicating the inside tube edge of the rack and inside tube edge of rear support bar (C) shown in Fig. 86. Once aligned, fully tighten all remaining screws (S7) using two 9/16" box end wrenches. Apply the same procedure to the passenger side.

**GOBI FORD BRONCO 2 & 4 DOOR HARD & SOFT TOP ROOF RACK
INSTALLATION INSTRUCTIONS****Fig. 87****Fig. 88****Fig. 89**

As shown in Fig. 87, fully tighten pivot screw (PS) using two 3/4" wrenches both driver and passenger. After the rear support bars (C) have been fully installed and tightened, you will notice that the rear isolator rubber pads (RP) are not contacting wear plate (IP) shown in Fig. 88. Turn each isolator screw both driver and passenger sides clockwise using the black plastic knobs as shown in Fig. 88, until rubber pads (RP) contact plate (IP). You may need to loosen jam nuts (J) shown in Fig. 88 to turn the isolator screw. As shown in Fig. 89, pull out on the rear driver support bar (C) in the direction of the red arrow each time you are turning the isolator screw inwards or clockwise. Pulling out on the rear support bar during each turn makes it possible to add pressure to each isolator screw. Turn each isolator screw clockwise until you have a measurement of at least 1-3/4" to 1-7/8" space between inside isolator support plate (ISP) and the face of wear plate (IP) as shown in Fig. 90 both passenger and driver sides. This will apply pressure to the roof rack support, preventing wobble or sway. After both isolator screws have been properly adjusted, use a 1/2" open end wrench and tighten jam nut (J) as shown in Fig. 90 approximately 1/2 turn each. This will prevent the isolator from coming loose during transport.

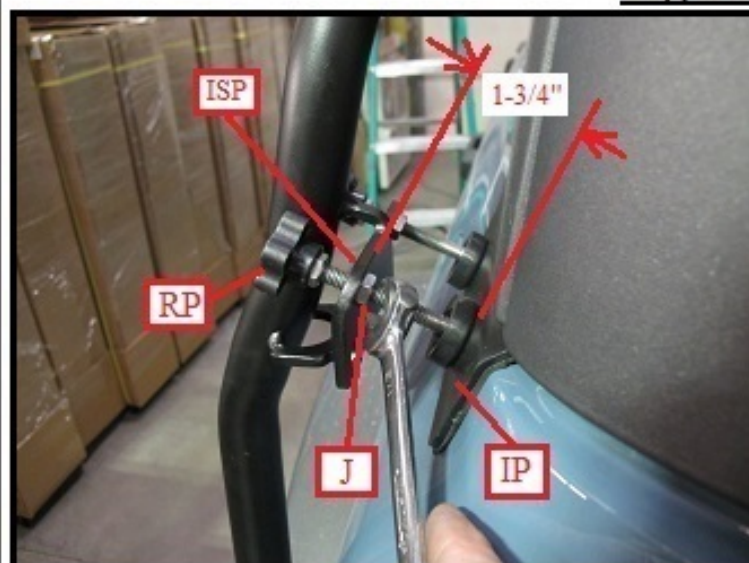
Fig. 90**Fig. 91**

As shown in Fig. 91, adjust both upper isolators (RP) driver and passenger sides so that the rubber pad is sitting off upper isolator wear plate (IP) approximately 1/32" to 1/16". Use two 1/2" open end wrenches and adjust upper isolator jam nuts (J) as shown in Fig. 91 then fully tighten in place. If you have a soft top you can choose to remove (RP) knob assembly completely or just leave in place. Refer back to Fig. 79 and fully tighten screws (S5) driver and passenger sides. **GOBI BRONCO ROOF RACK INSTALL COMPLETED.**

GOBI FORD BRONCO 2 & 4 DOOR HARD & SOFT TOP ROOF RACK INSTALLATION INSTRUCTIONS



GOBI BRONCO ROOF RACK INSTALLATION COMPLETED

- CAUTION:** * DO NOT REST THE GOBI ROOF RACK ON THE REAR BUMPER AS DAMAGE CAN RESULT
- * EXCESSIVE SPEEDS OVER ROUGH TERRAIN WITH OR WITHOUT A FULLY LOADED ROOF RACK ARE NOT RECOMMENDED AS DAMAGE CAN OCCUR TO ROOF RACK OR VEHICLE.

Recommended Attachments for soft top use:

- A) "Quick Release" part #GJLSK1SRIL for easy and quick release of the roof rack
- B) "Sun Roof Insert" part #GJLSRI

To purchase these or other Gobi attachments please contact a Gobi online dealer or Gobi Racks direct at 1-720-479-9372 or e-mail to sales@gobiracks.com Thank you for your purchase

INTELLIGENT DESIGNS 2000 CORPORATION

This limited one year warranty covers ONLY Intelligent Designs 2000, Corporation ("ID2000") products. Please review the terms and conditions of the limited warranties below.

LIMITED ONE YEAR WARRANTY

All warranties and representations, except as set out below, are hereby disclaimed, (including fitness for the purchaser's intended use or purpose and merchantability), all products being sold AS IS, without warranty beyond that made herein, with the purchaser assuming: 1) the entire risk as to the quality and performance of the goods, 2) the cost of any repairs not covered herein.

Intelligent Designs 2000 Corporation warrants, as limited herein, to the original purchaser that its product which have been properly installed per provided instructions are free from defects in material and/or workmanship. At Intelligent Designs 2000 option, the purchaser's remedy hereunder shall be limited to repair or replacement of defective parts returned to the place of purchase or to Intelligent Designs 2000 at the purchaser's expense.

Intelligent Designs 2000 warranty, as herein, shall only be effective while the original purchaser owns the vehicle on which the product or products was installed and shall not apply if the product has been removed from the original vehicle. Intelligent Designs 2000 warranty is void if any damage to the product or products is due to misuse, abuse, neglect, accident, improper installation, or contact with on-road or off-road hazards, product modification, improper or inadequate maintenance or any use contrary to the instructions accompanying the product. Intelligent Designs 2000 warranty only covers the cost of the defective part and not the cost of removal, installation, and painting or other incidental or consequential charges or damages, or personal injury damages, and does not cover use of any product on racing vehicles. Intelligent Designs 2000's warranty is not transferable from the original purchaser.

THIS LIMITED WARRANTY DOES NOT APPLY TO:

1. Damages or problems that result from shipping, installation, maintenance, or separate system components.
2. Damages or problems that result from misuse, abuse, operation outside environmental specifications or contrary to the requirements or precautions in the installation instructions, accident, lightning strikes or other natural causes, unauthorized modification or alteration, incorrect electrical current or voltage, other causes not arising out of defect in material or workmanship.
3. Therefore, the cost of repair or replacement of such defective product shall be borne by the customer.

To assure product quality, Intelligent Designs 2000 reserves the right to change product designs, materials, specifications and finishes without prior notice to customers. Intelligent Designs 2000's warranty gives you specific legal rights and you may also have other rights, which vary from state to state. Some states do not limitations on how long an implied warranty lasts, so the above limitations may not apply to you. Also, some states do not allow the exclusion or limitation of incidental or consequential damages so the above limitations or exclusions may not apply to you. Intelligent Designs 2000 reserves the right to discontinue product lines and substitute products or provide other remedies other than those listed in the limited warranty for those discontinued products.

THIS WARRANTY IS IN LIEU OF ANY OTHER WARRANTIES, EXPRESS OR IMPLIED, INCLUDING WITHOUT LIMITATION, ANY WARRANTY OF MERCHANTABILITY OR FITNESS FOR A PARTICULAR PURPOSE. TO THE EXTENT ANY IMPLIED WARRANTY IS REQUIRED BY LAW, IT IS LIMITED IN DURATION TO THE EXPRESS WARRANTY PERIOD ABOVE. INTELLIGENT DESIGNS 2000 CORPORATION/ GOBI RACKS USA WILL NOT BE LIABLE FOR ANY CONSEQUENTIAL, INDIRECT, OR INCIDENTAL DAMAGES OF ANY KIND INCLUDING LOSS OF REVENUES OR PROFITS, IN CONNECTION WITH THE PRODUCT(S). SOME STATES DO NOT ALLOW LIMITATIONS ON HOW LONG AN IMPLIED WARRANTY LASTS OR THE EXCLUSION OF INCIDENTAL OR CONSEQUENTIAL DAMAGES, SO THE ABOVE LIMITATIONS OR EXCLUSIONS MAY NOT APPLY TO YOU.

REQUESTING WARRANTY COVERAGE

For this warranty to be effective, it is strongly recommended that the purchaser completes and returns the warranty registration to Intelligent Designs 2000 within ten days of the date of purchase. Replacement parts can be obtained by returning the part along with proof of purchase. Warranty claims cannot be determined until the merchandise is received and inspected. **Returns made to Intelligent Designs 2000 will not be accepted without prior authorization from Intelligent Designs 2000. This included but is not limited to all shipping costs and all other incidental costs to be paid by the customer. Please call the customer service department at the number below.**

LIMITED LIABILITY WARRANTY

Intelligent Designs 2000 Corporation warrants this product to be free of original defects in materials or workmanship as long as the original purchaser owns the motor vehicle on which it is installed. This warranty does not cover damage resulting from accident, misuse or abuse, neglect, lack of reasonable care, or improper installation. The Company will repair or replace, at its option, any product covered by this warranty that becomes defective. This is a parts-only warranty and such repair or replacement shall be the Company's sole obligation and the customer's sole remedy for a defective product. The Company shall have no liability for personal injury, property damage, incidental, or consequential damages of any kind or nature. **THIS FOREGOING WARRANTIES ARE EXCLUSIVE AND IN LIEU OF ALL OTHER WARRANTIES, EXPRESS OR IMPLIED, AND THE COMPANY DISCLAIMS ALL OTHER WARRANTIES, EXPRESS OR IMPLIED, INCLUDING, WITHOUT LIMITATION, ANY IMPLIED WARRANTY OR MERCHANTABILITY OR FITNESS FOR A PARTICULAR PURPOSE.**

To obtain warranty service, return this portion to Intelligent Designs 2000 Corporation with a proof of purchase to the address below. Please include:

First Name _____ Last Name _____
Address _____ City _____
E-mail _____ State _____
Phone Number _____ Zip Code _____