

GOBI JEEP JK 2 & 4 DOOR ROOF RACK GEN 3

INSTALLATION INSTRUCTIONS

The rack must be inspected before each use to make certain attachments are secure, and for evidence of wear. Misuse of the rack or failure to observe the manufacturer's instructions as to installation, proper Attachment and maintenance will void warranties that may be implied by law.

TOOLS REQUIRED FOR INSTALLATION:

- 1- 15mm socket or box end wrench (rear bumper)**
- 1- 9/16" socket or box end wrench (rear tower and rack)**
- 1- 3/4" socket and 3/4" box end or adjustable wrench (rear bar)**
- 1- 1/2" open end wrench (isolators)**
- 1- Torx bit T-40 (light bar)**

CAUTION

**USE ANTI-SEIZE LUBRICANT
ON ALL SCREWS**

GOBI JEEP JK 2 & 4 DOOR ROOF RACK GEN 3

INSTALLATION INSTRUCTIONS

Guidelines:

When using Load Carriers and Accessories, the user must understand the precautions. The points listed below will assist you in using the rack /carrier system and will encourage safety.

- For quality fits and safty, use only the recommended rack or accessory. Do not assume an accessory will fit, always check with dealer when obtaining new accessories. Use only approved accessories on load carriers. Using other brands will void your warrenty.
- Make sure all knobs, bolts, screws, straps, and locks are firmly attached, tightened and locked before every trip. Knobs, bolts, screws, straps, and locks must be periodically inspected for signs of wear, corrosion, and fatigue. Check your load at stops during the trip to insure continued fastening security.
- Check local and state laws governing projection of objects beyound the width of a vehicle. **Be aware of the width and height of your cargo since low clearance branches, bridges, and parking garages can affect the load** All cargo will affect the vehicle's driving behavior. Never drive with any lock, know, or rack in an open or unlocked position. All long loads such as, but not limited to sailboards, surfboards, kayaks, canoes, and lumber must be tied down front and rear to the bumpers or tow hooks, of the vehicle.
- Remove your rack accessories when they are not in use, before intering car washes, prior to taking in your vehicle for service, and whenever clearance may be an issue.
- All locks must be turned and moved periodically to insure smooth operation. Use graphite or similar dry lubricant to help this. Locks are designed to deter vandalism and theft. Remove valuable gear if your vehicle is unattended for an extended period. Place at least one key in the glove compartment.
- For safety to your vehicle and rack system, obey all posted speed limits and traffic cautions. Adapt your speed to the conditions of the road and the load being carried.
- Do not use load carriers and accessories for purposes other than those for which they were designed. Do not exceed their carrying capacity.
- Consult with your dealer if you have any questions regarding the operations and limits of this product. Review all instructions carefully.

READ ALL INSTRUCTIONS PRIOR TO INSTALLATION

GOBI JEEP JK 2 & 4 DOOR ROOF RACK GEN 3 INSTALLATION INSTRUCTIONS

Included in kit

Letter	Description	Location	Quantity
A	GOBI JEEP JK 2 & 4 DOOR ROOF RACK GEN 3	Main box	1
B	GOBI JEEP JK STEALTH FRONT LIGHT BAR	Strapped to Rack	1
C	GOBI JEEP JK STEALTH ROOF RACK REAR SUPPORT	Strapped to Rack	1 ea.
D	REAR RACK SUPPORT TOWERS PASSENGER AND DRIVER GEN 3	Hardware Box	1 ea.
E	REAR TOWER SUPPORT PLATES PASSENGER AND DRIVER	Hardware Box	1 ea.
F	GOBI WINDSHIELD BODY PROTECTION PASSENGER AND DRIVER	BAG #2	1 ea.
G	<p>GOBI RACK MOUNTING HARDWARE</p> <p><u>CONTENTS:</u></p> <p>4- Black nylon shoulder washers 4- 1/2" Flat washer SS 2- 1/2" x 2-1/2" hex head screw SS 2- 1/2" Nylock nuts SS 8- 3/8-16 x 1" hex head screw SS 28- 3/8" Flat washer SS 16- 3/8" Nylock nuts SS</p> <p>4- 3/8" x 1" Carriage screws SS 4- 3/8" x 1-1/4" Carriage screws SS 2- 3/8-16 x 3/4" Hex head screw 2- 3/8-16 x 2" Hex head screw 4- 3/8" Lock washer SS 1- Packet Anti-seize lubricant</p>	BAG #3 Hardware Box	1
H	<p>GOBI ISOLATOR WEAR PLATES</p> <p><u>CONTENTS:</u> 2- Black Triangular adhesive backed wear plates (Place on vehicle body under Rubber Isolators 21) 2- Oval Black aluminum adhesive backed wear plate (Place on vehicle body under Tower stand offs 12)</p>	BAG #4 Hardware Box	1

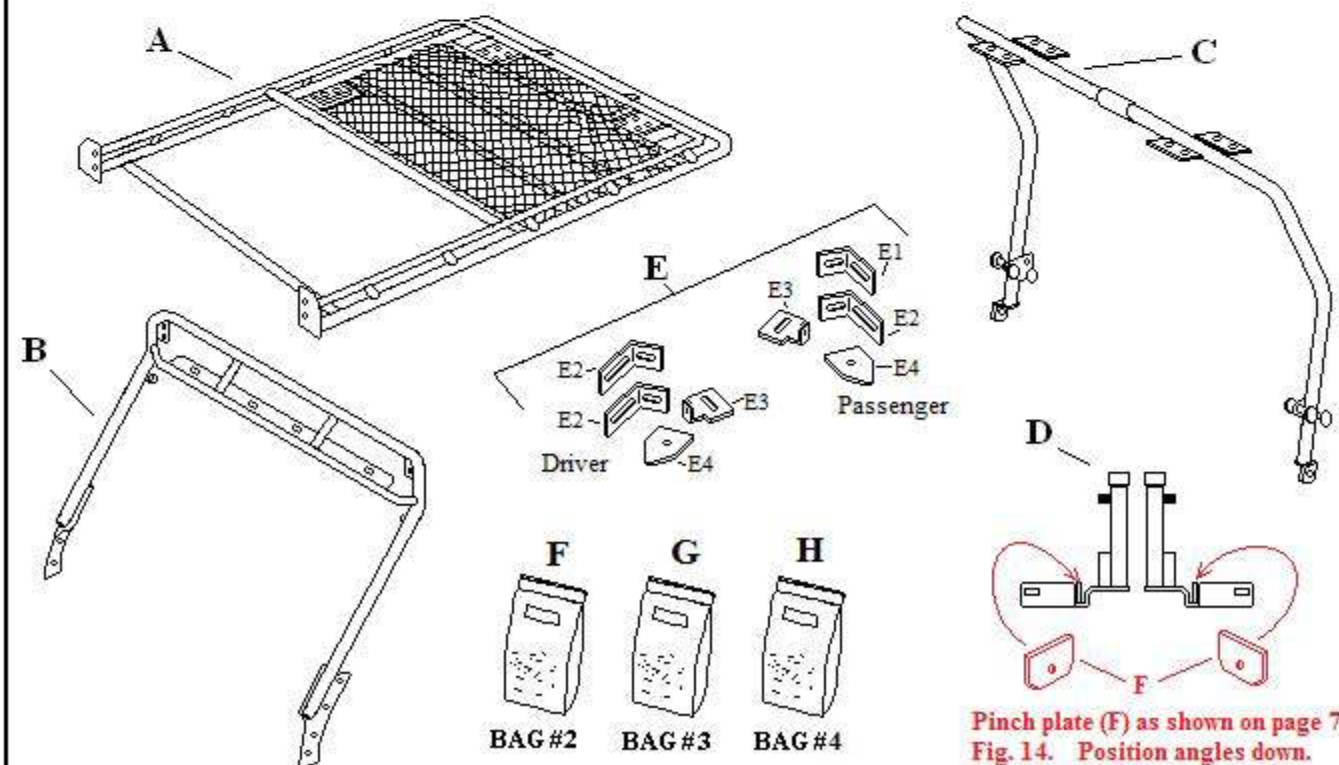

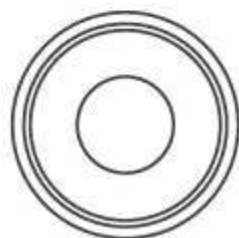
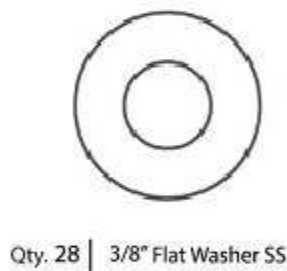
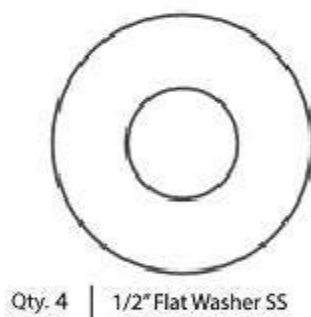
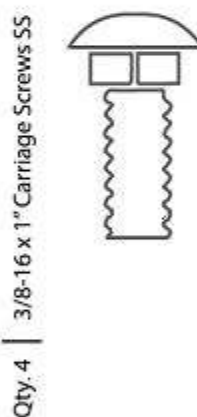
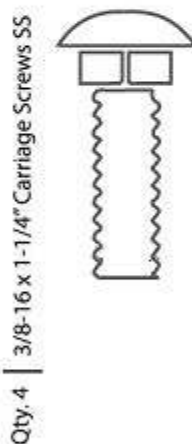
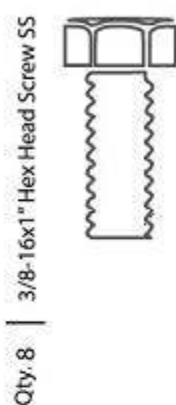
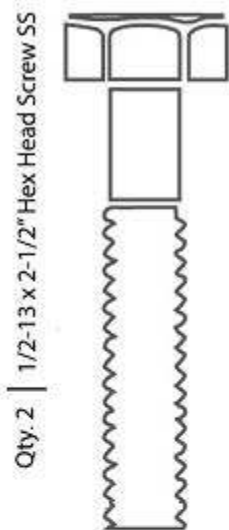
**GOBI JEEP JK 2 & 4 DOOR ROOF RACK GEN 3
INSTALLATION INSTRUCTIONS**

Qty. 4 | Black Nylon Should Washer

Qty. 2 | 1/2" Nylock Nuts SS

Qty. 16 | 3/8" Nylock Nuts SS

Qty. 4 | 3/8" Lock Washer SS

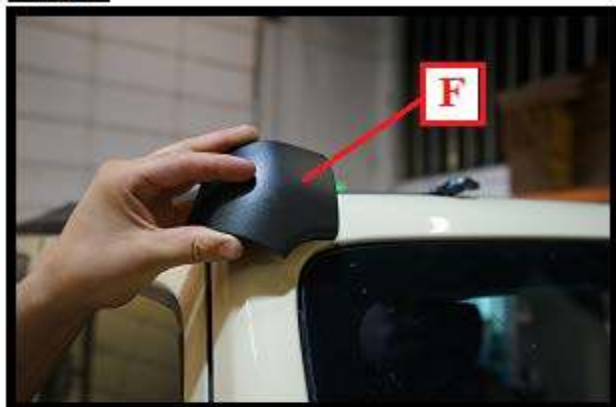
GOBI JEEP JK 2 & 4 DOOR ROOF RACK GEN 3**INSTALLATION INSTRUCTIONS****Fig. 1****Fig. 2**

Remove from your hardware kit windshield body protection covers (F) located in Bag #2. Take out the passenger side cover indicated by the letter (P) on the front lip of the cover as shown in Fig.1. Place the cover on the passenger side top corner of your windshield as shown in Fig. 2 and Fig. 3 shift the cover around slightly until it sits firmly on the corner of the windshield then place a piece of masking tape on the windshield next to both edges of the cover as shown in Fig. 3 to indicate position.

Fig. 3**Fig. 4**

Remove the cover from the masking tape markers and clean the area inside the masking tape markers with denatured alcohol let dry for 30 seconds. Peel off the adhesive protective film from inside the cover as shown in Fig. 4 and set back inside masking tape markers placing the lip of the cover back into the recess on the edge of the windshield glass as shown in Fig. 2. Then set the entire cover on the windshield frame as shown in Fig. 3 pressing down firmly for at least 30 seconds. Apply the same procedure to the driver side.

GOBI JEEP JK 2 & 4 DOOR ROOF RACK GEN 3 INSTALLATION INSTRUCTIONS

Fig. 5**Fig. 6**

Remove the rear triangular wear plates (I) located in Bag #4 of your hardware kit. Take out the passenger side wear plate as shown in Fig. 5 (*do not peel off the adhesive protective film at this time*) and place it on the rear upper passenger side corner of the body as shown in Fig. 6. Move the wear plate around until it fits with the top formed edge of the body (A1) and contacts the rear tail light cover (A2). Once you have a firm fit place a masking tape marker as shown in Fig. 6 to indicate position.

Fig. 7**Fig. 8**

Remove the cover from the masking tape marker and clean the area where the wear plate will sit with denatured alcohol let sit for 30 seconds to dry. Peel off the adhesive protective film from the back of the wear plate as shown in Fig. 8 and set back onto the rear upper corner of the vehicle using the masking tape marker. Once set in place apply pressure for at least 30 seconds. Apply the same procedure to the driver side.

GOBI JEEP JK 2 & 4 DOOR ROOF RACK GEN 3 INSTALLATION INSTRUCTIONS

Fig. 9

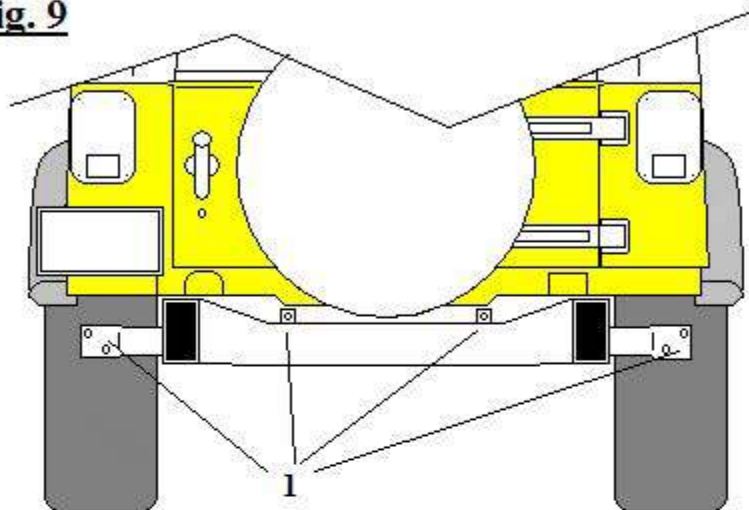

Remove the rear bumper from vehicle as shown in Fig. 10 below by taking out all 6 10mm hex head screws (1) using a 15mm ratchet as shown in Fig. 9 above.

Fig. 10

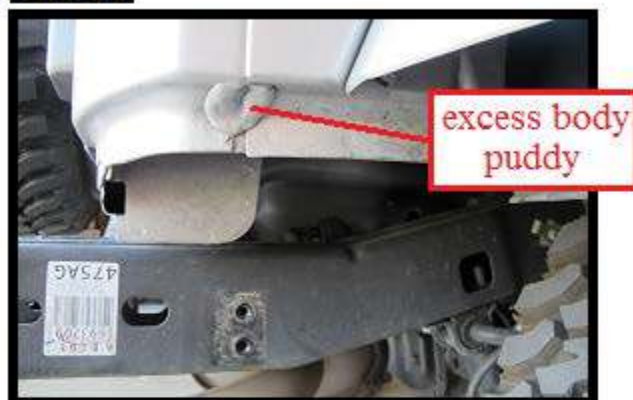

GOBI JEEP JK 2 & 4 DOOR ROOF RACK GEN 3 INSTALLATION INSTRUCTIONS

Fig. 11

If excess body putty is present on rear body pinch seam as shown in Fig. 11 passenger side remove with plastic tool so that the body seam is free from any obstructions. Correctly staged body seam shown in Fig. 12.

Fig. 12

Clean all dirt and debris from the underside of body tub (T) both passenger and driver sides.

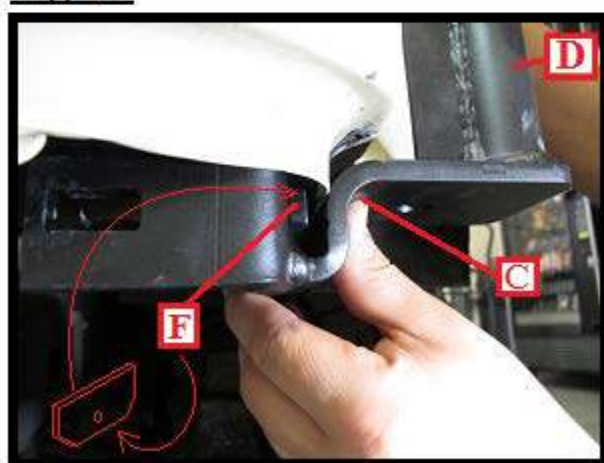
Fig. 13**Fig. 14**

Remove from your hardware box the passenger side support Tower (D) indicated by a printed label (PASSENGER SIDE). Slide Tower (D) up onto the rear passenger side body pinch seam with pinch plate (F) positioned on the inside of body as shown in Fig. 13 and Fig. 14. Make certain the angles of pinch plate (F) are faced down. Make certain that Tower (D) is pushed up as high as possible so that the curved section (C) of the Tower support plate mates with the curved area of the Body as shown in Fig. 14, 15 and Fig. 16. (A rubber mallet may be required in some cases to push up Tower (D) in place).

GOBI JEEP JK 2 & 4 DOOR ROOF RACK GEN 3

INSTALLATION INSTRUCTIONS

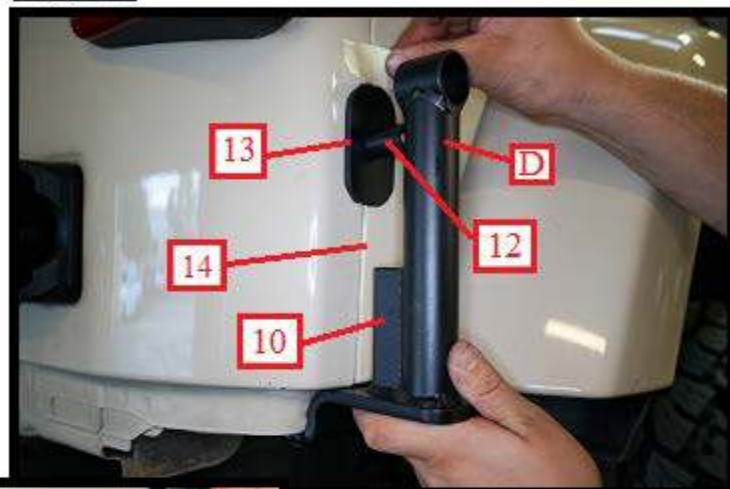
Fig. 15

After you have fully pushed up the passenger side support tower in place (*a rubber mallet may be required in some cases*) as shown in Fig. 15 and Fig. 16 align the tower flange (10) Fig. 15 and the center of the upper tower tube (11) Fig. 17 with body seam (14) and hold in place with one hand. Remove from your hardware kit Bag #4 one black oval wear plate (13) (*do not peel off the protective adhesive film*). Slide oval plate (13) behind tower standoff (12) so that the center hole of plate (13) fits over the center raised knob of tower standoff (12) and body seam (14).

**Fig. 16**

Hold plate and tower in place against vehicle body with one hand then apply a piece of masking tape on the body above the oval wear plate to use as a marker shown in Fig. 15 and Fig. 18. Remove tower (D) and wear plate (13) and clean off the surface area of the body where the oval plate will be placed with denatured alcohol then let dry for 30 seconds. Peel off the adhesive film from wear plate (13) and adhere the wear plate to the vehicle body under the masking tape marker and in line with the body seam (14) as shown in Fig. 18.

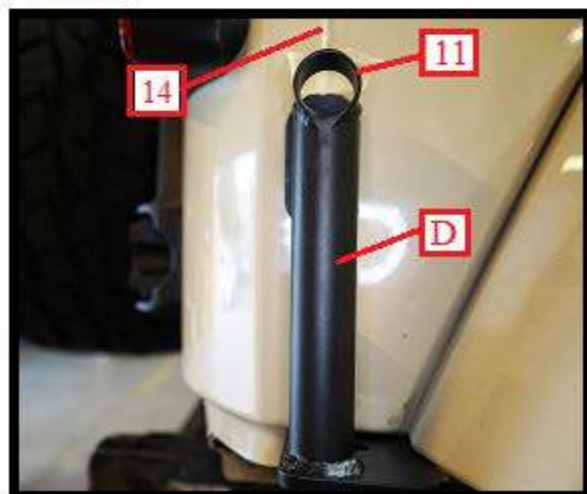
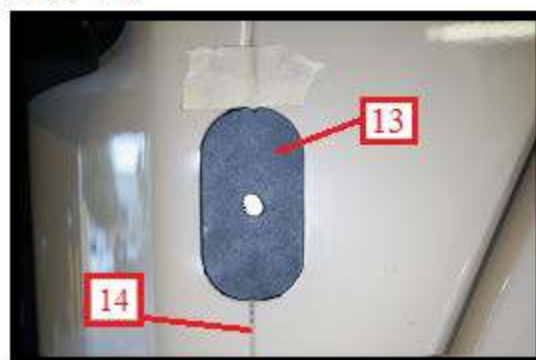
Fig. 17**Fig. 18**

GOBI JEEP JK 2 & 4 DOOR ROOF RACK GEN 3 INSTALLATION INSTRUCTIONS

Fig.19

Reinstall Tower (D) as shown in Fig. 15,16 and Fig. 17 then completely tighten both 3/8" hex head screws until the lock washers are fully flattened, using a 9/16" ratchet or boxed end wrench while applying upwards pressure to Tower (D) as shown by the red arrow in Fig. 19.

Apply Anti-Seize
lubricant to all
threaded screws.

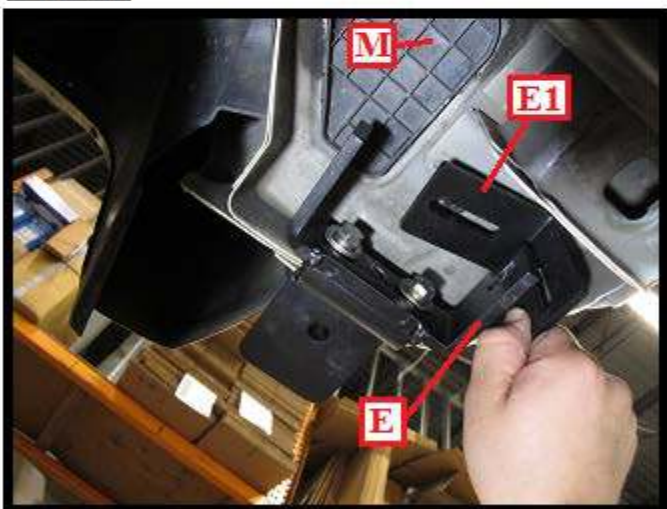
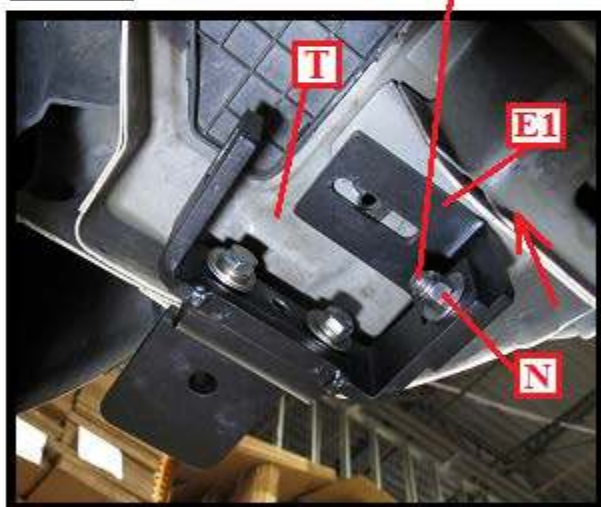
**Fig. 20****Fig. 21**

As shown in Fig. 20 slide the short passenger side tower support bracket (E1) with the long slot facing upwards over the tower support arm (E) opposite the plastic cover (M). Install one 3/8-16 x 1-1/4" carriage screw, 3/8" flat washer and 3/8" nylock nut (N) located in Bag #3 of your hardware kit as shown in Fig. 21. Push up support bracket (E1) in the direction of the red arrow as shown in Fig. 21 until it contacts the bottom of tub (T) and align the slot of bracket (E1) with the hole in the bottom of tub (T) and snug down only, leave some play for adjustment.

GOBI JEEP JK 2 & 4 DOOR ROOF RACK GEN 3 INSTALLATION INSTRUCTIONS

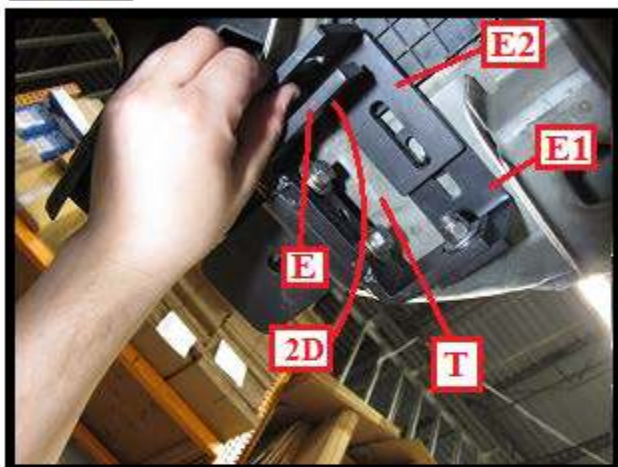
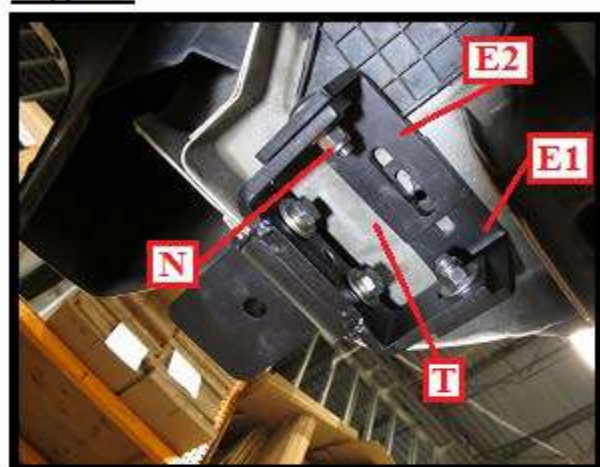
Fig. 22**Fig. 23**

Slip tower support bracket (E2) with the longer slot facing up over the support arm (E) and onto bracket (E1) as shown in Fig. 22. **If you should have a 2 door Jeep slip support bracket (E2) on the inside of support arm (E) indicated by (2D).** Align bracket slot (E2) with the hole in tub floor (T) as shown in Fig. 23. Install one 3/8-16 x 1-1/4" carriage screw, 3/8" flat washer and 3/8" nylock nut (N) located in Bag #3 of your hardware kit as shown in Fig. 23. Push up support bracket (E2) shown in Fig. 23 until it contacts the bottom of support bracket (E1) keep aligned and snug down only, leave some play for adjustment.

Fig. 24**Fig. 25****Unplug connector****Fig. 24a**

As shown in Fig. 24 use a Phillips screw driver and remove only the two left side screws (S) of the rear passenger side tail light. As shown in Fig. 24a remove the entire tail light and unplug the rear tail light electrical connector and set tail light aside for now. As shown in Fig. 25 reach down inside rear tail light fender cavity and remove any foam which is covering the tub floor access hole (T). Only remove the foam directly around the access hole on tub floor and make certain the floor is relatively clean and flat.

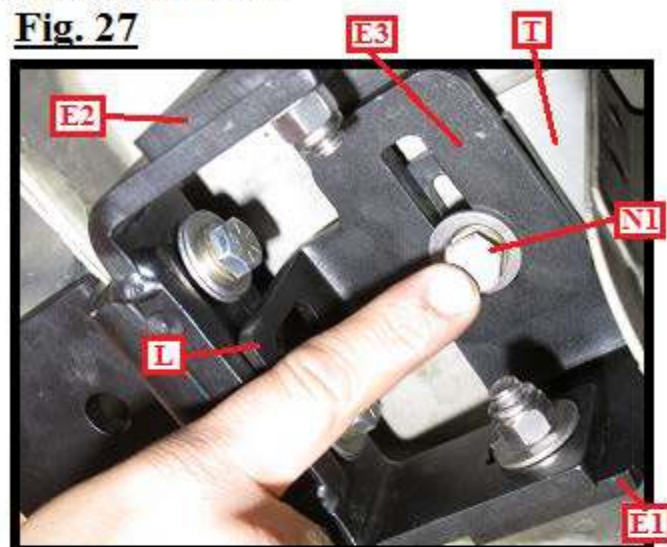
GOBI JEEP JK 2 & 4 DOOR ROOF RACK GEN 3**INSTALLATION INSTRUCTIONS****Fig. 26****Fig. 27**

Remove washer plate (E3) from your hardware kit and slip a 3/8-16 x 2" hex head screw, lock washer and flat washer (N1) from Bag #3 through washer plate (E3) as shown in Fig. 26. Insert assembly (E3) / (N1) up into the hole in tub floor (T) passing through tower support brackets (E2) and (E1) as shown in Fig. 27. Brackets (E2) and (E1) may need to be loosened to pass screw (N1) through all parts then into tub hole (T). Make certain tab (L) of washer plate (E3) is positioned between the two hex head screws as shown in Fig. 27. With one hand hold washer plate assembly (E3) / (N1) up in place and with the other hand slip nut plate (E4) into rear body tail light cavity as shown in Fig. 28 and Fig. 29 then thread screw (N1) into nut plate (E4) as shown in Fig. 30.

**Fig. 28**

Remove from your hardware kit nut plate (E4) and place it down inside the rear tail light cavity.

**Fig. 29**

Align the hole of nut plate (E4) with the hole at the bottom floor of tub (T). Direct the point of nut plate as shown.

Fig. 30

With one hand partially thread screw (N1) up into nut plate (E4) shown in Figures 27 thru 29.

GOBI JEEP JK 2 & 4 DOOR ROOF RACK GEN 3 INSTALLATION INSTRUCTIONS

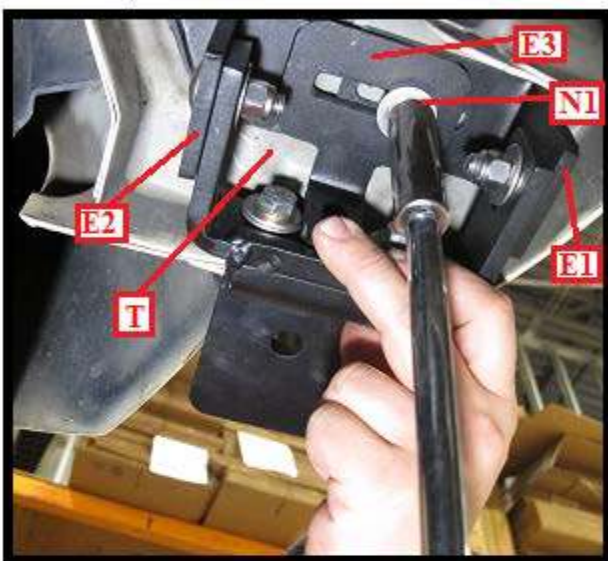
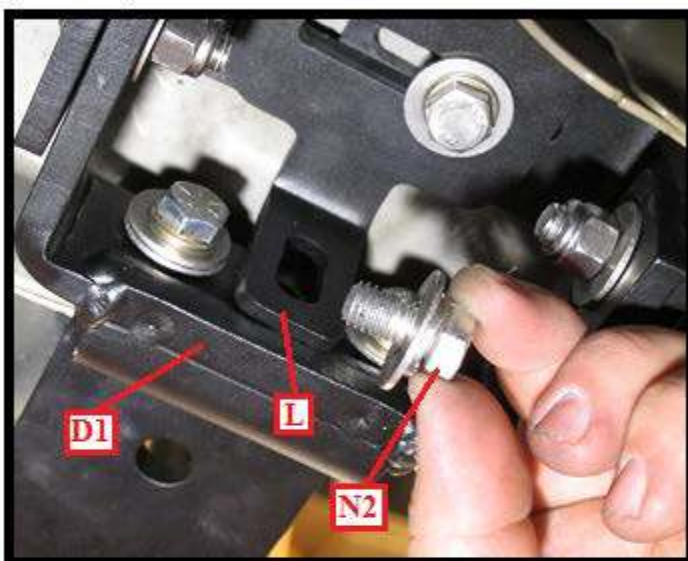
Fig. 31**Fig. 32**

As shown in Fig. 31 make certain all parts (E1), (E2) and (E3) are closely fitted but still adjustable. Using a 9/16" ratchet tighten screw (N1) drawing all parts upwards until they are snug up against tub floor (T) but still adjustable. Center tab (L) between both hex head screws and push against tower base (D1) as shown in Fig. 32 then thread a 3/8-16 x 3/4" hex head screw and flat washer (N2) located in Bag #3 of your hardware kit and snug down to a close fit leave loose enough for adjustment.

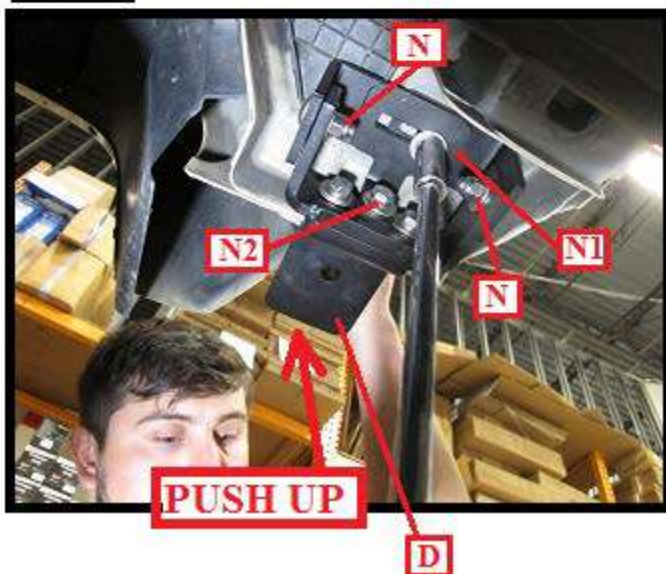
Fig. 33

While pushing up on Tower base (D) as shown in Fig. 33 and Fig. 19 fully tighten screw (N1) using a 9/16" ratchet then follow by fully tightening 2 screws (N) and 1 screw (N2) using a 9/16" ratchet or box end wrench. Secure tail light housing back in place by reversing the procedure in Figures 24 and 24a.

PASSENGER SIDE TOWER
INSTALLATION COMPLETED.

GOBI JEEP JK 2 & 4 DOOR ROOF RACK GEN 3 INSTALLATION INSTRUCTIONS

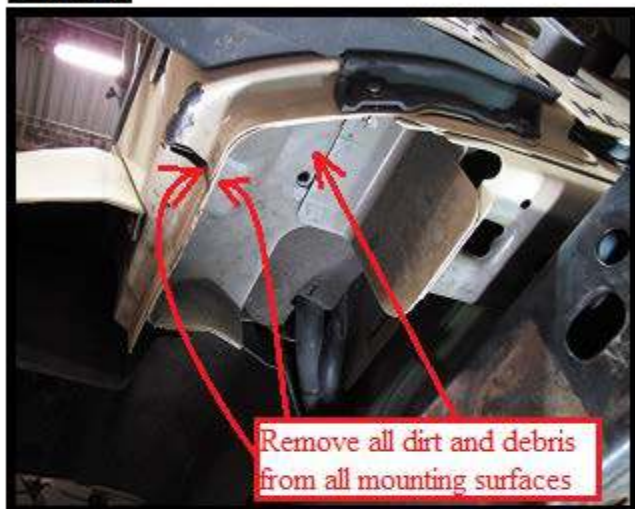
Fig. 34**Fig. 35**

Driver side Tower install is very similar to the passenger side. First clean the lower tub surface along with the pinch seam surfaces inside and out as shown in Fig. 34. Install the Driver side tower shown in Fig. 35 in the same manner and procedure as shown in Figures 11 thru 19 and fully tighten in place.

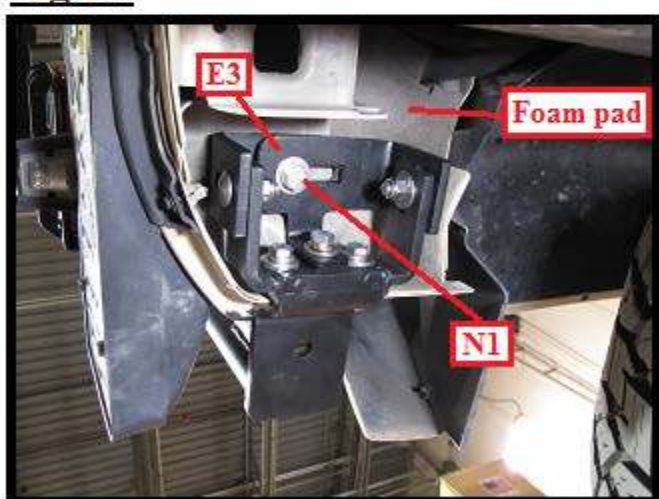
Fig. 36**Fig. 37**

Install both tower bracket supports (E2) shown in Fig. 36 as completed in Figures 20 thru 23. Then install washer plate (E3) shown in Fig. 37 as completed in Figures 26 and 27. Slip nut plate (E4) above tub floor (T) as shown in Fig. 36 by pushing foam pad up and out of the way. Thread washer plate assembly (E3) / (N1) into nut plate and complete the installation process as shown in Figures 31, 32 and 33 then fully tighten in place. DRIVER SIDE TOWER INSTALLATION COMPLETED.

GOBI JEEP JK 2 & 4 DOOR ROOF RACK GEN 3 INSTALLATION INSTRUCTIONS

Fig. 38

Install rear bumper back in place and tighten all screws

Fig. 39

Finished tower install
driver side

Fig. 40

Finished tower install
Passenger side

GOBI LIGHT BAR INSTALLATION

Fig. 41

Remove 4 Torx head screws from the passenger and driver side windshield as shown above using a #40 Torx drive. Keep all 8 screws nearby as they will be used to mount the Gobi light bar.

Fig. 42

With the help of another install the Gobi light bar by sliding on the passenger side first as shown above.

GOBI JEEP JK 2 & 4 DOOR ROOF RACK GEN 3

INSTALLATION INSTRUCTIONS

Fig. 43

Thread in place only one Torx head screw into the last hole of the light bar and windshield as shown. Finger tighten in place at this time.

Fig. 44

Pull the driver side leg of the Gobi light bar down in place as shown by the red arrow. Thread in only one Torx head screw into the last hole of the light bar and vehicle windshield and finger tighten at this time.

Fig. 45

With the help of another person pull back Gobi light bar as indicated by a red arrow shown in Fig. 45 so that the rubber bumper of the light bar is compressed against the body protection cover plate as installed in Fig. 1 thru 4. Thread in all remaining Torx head screws on driver side and fully tighten in place.

Fig. 46

With the help of another person pull back the Gobi light bar on the passenger side in the same manner as the driver side. Thread in all remaining Torx head screws and fully tighten in place.

LIGHT BAR INSTALLATION COMPLETED

GOBI JEEP JK 2 & 4 DOOR ROOF RACK GEN 3**INSTALLATION INSTRUCTIONS****Fig. 47**

Place a blanket or similar covering over the top of the jeep to prevent any marring of the hard top or soft top.

Fig. 48

Remove the rear support bar (C) from your hardware kit and install as shown in Fig. 48 and Fig. 49 using hardware located in Bag #3 of your hardware kit.

Fig. 49

Use one 1/2" x 2-1/2" hex head screw, two 1/2" flat washers two black nylon bushings and one 1/2" nylock nut located in Bag #3 of your hardware kit in the order shown above and snug down only at this time. Apply the same procedure to the opposite side.

Fig. 50

Gently rest the rear support bar (C) as shown onto the covering on top of the vehicle. You may want to place an additional covering over the rear support bar itself as the roof rack basket will need to be laid over the top of the rear support bar.

GOBI JEEP JK 2 & 4 DOOR ROOF RACK GEN 3 INSTALLATION INSTRUCTIONS

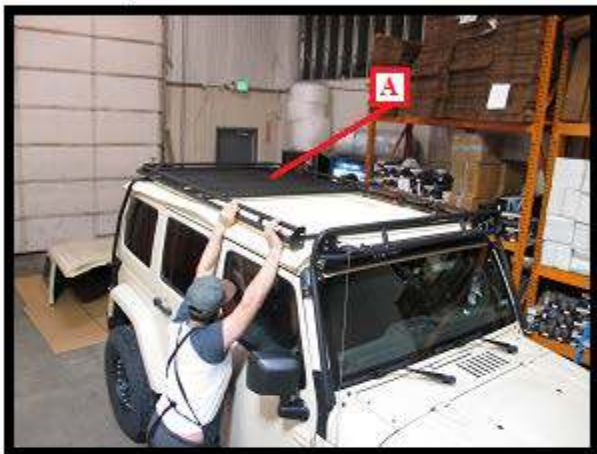
Fig. 51

With the help of others lift the Gobi rack basket (A) over the top of the vehicle and lay gently over the rear support bar and behind the Gobi light bar as shown.

Fig. 52

Align the front of the roof rack basket mounting holes with the light bar as shown in Fig. 52 above and Fig. 53.

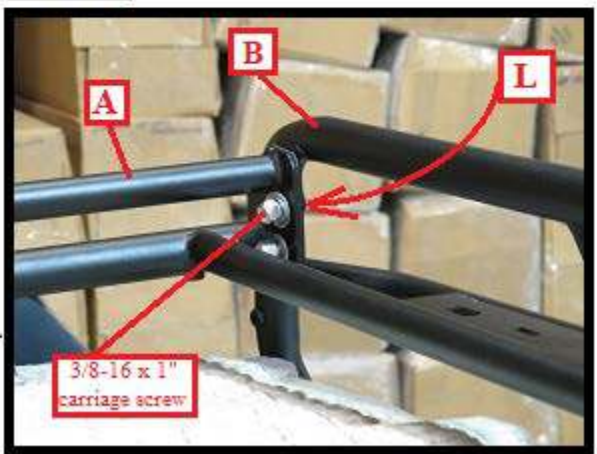
Fig. 53

Use four 3/8-16 x 1" carriage screws two per side of light bar (B) located in Bag #3 of your hardware kit. Make certain that you push the screws in from the front of the light bar in the direction of the red arrow (L) as shown in Fig. 53 then into roof rack (A). Thread on one 3/8" flat washer and one 3/8" nylock nut per screw and snug down. Do not fully tighten as adjustments will be made later.

GOBI JEEP JK 2 & 4 DOOR ROOF RACK GEN 3

INSTALLATION INSTRUCTIONS

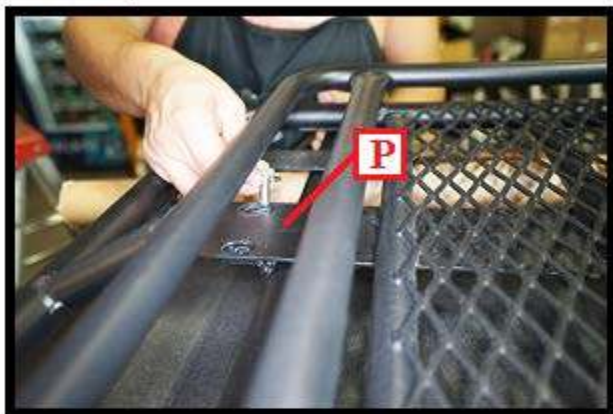
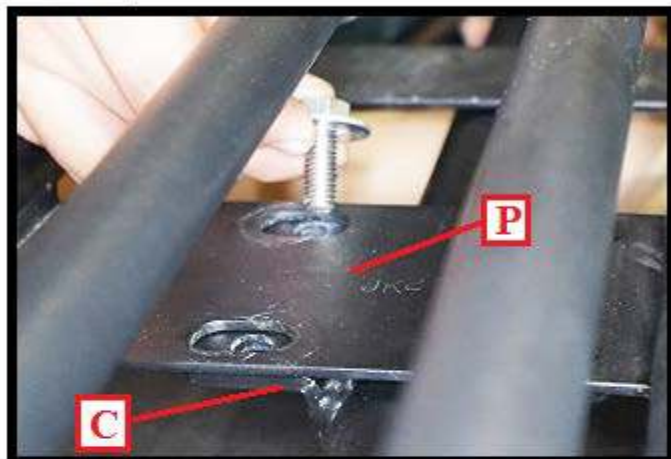
Fig. 54**Fig. 55**

Remove from Bag #3 eight 3/8-16 x 1" hex head screws, sixteen flat washers and eight nylock nuts. Install each 3/8" hex screw with one flat washer as shown in Fig. 54 and Fig. 55 through top of roof rack rear support plate (P) then into rear support bar (C). Use a 3/8" flat washer and 3/8" nylock nut under and snug down in place. Leave loose enough to move for adjustment.

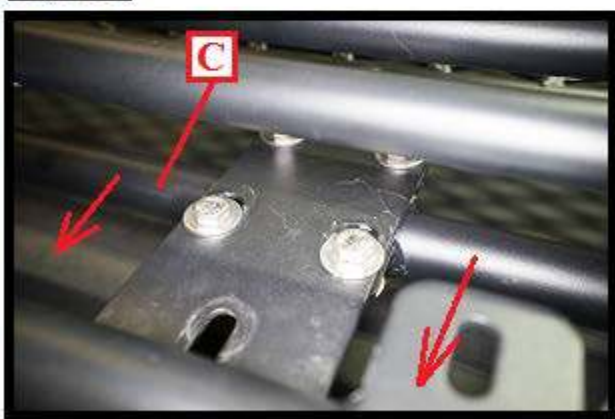
Fig. 56**Fig. 57**

As shown in Fig. 56 once all screws, flat washers and nuts have been installed and snugged down slide both sides of rear support bar (C) to the rear of the roof rack as shown by the red arrows in Fig. 57. Fully tighten all eight screws and nuts at this time.

GOBI JEEP JK 2 & 4 DOOR ROOF RACK GEN 3

INSTALLATION INSTRUCTIONS

Fig. 58

Fully tighten passenger and driver rear pivot screws using a 3/4" ratchet and adjustable wrench or two 3/4" open end wrenches

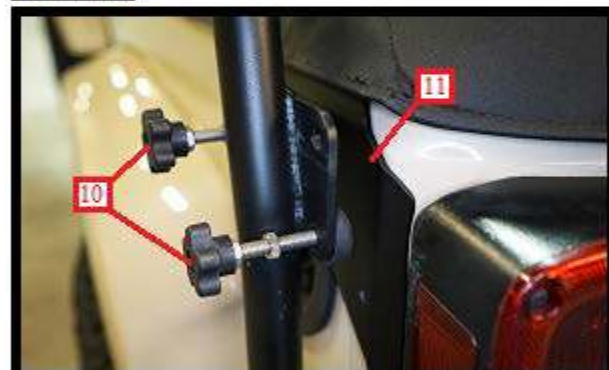
Fig. 60

Turn isolator screws (10) clockwise until they make contact with wear plate (11) both passenger and driver sides

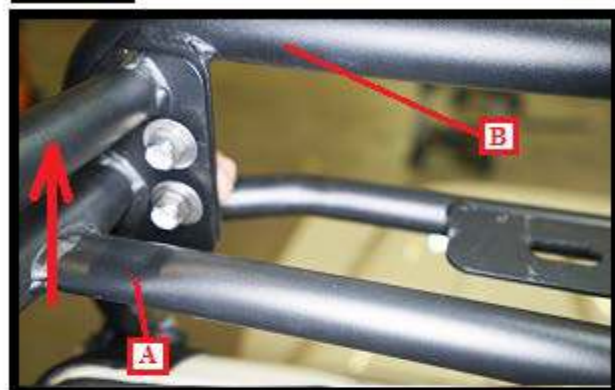
Fig. 62**Fig. 59**

Lift up roof rack (A) just behind light bar (B) in the direction of red arrow both driver and passenger sides and hold in place. Fully tighten all four screws using a 9/16" open end wrench.

Fig. 61

Isolators must be turned in tightly to remove rear rack play. To make this process easy pull out on rear support bar (C) during each turn to reduce the pressure on the isolator. Make certain you apply at least 2 to 3 full turns each isolator both passenger and driver sides

After you have properly tensioned both the driver and passenger side isolators set them in place by turning jam nut (M) 1/2 turn clockwise to prevent the isolators from loosening during travel.

GOBI JEEP JK 2 & 4 DOOR ROOF RACK GEN 3 INSTALLATION INSTRUCTIONS



Roof rack installation completed

CAUTION: * DO NOT REST THE GOBI ROOF RACK ON THE REAR BUMPER AS DAMAGE CAN RESULT FROM THE WEIGHT OF THE ROOF RACK ON THE REAR LICENSE PLATE FRAME OR PLASTIC BUMPER.

* EXCESSIVE SPEEDS OVER ROUGH TERRAIN WITH OR WITHOUT A FULLY LOADED ROOF RACK ARE NOT RECOMMENDED AS DAMAGE CAN OCCUR TO ROOF RACK OR VEHICLE.

Recommended Attachments:

- A) "QUICK RELEASE" part #GJJKQR for easy and quick release of the roof rack for soft top retraction.
- B) "Upper rear Isolators" part #GJJKRUI prevents rear upper roof rack movement during off road driving with heavy loads. For hard top use only. (recommended for use with roof top tents)

To purchase these or other Gobi attachments please contact a Gobi online dealer or Gobi Racks direct at 1-720-479-9372 or e-mail to sales@gobiracks.com Thank you for your purchase