

GOBI JEEP JL FRONT RACK SUPPORT/LIGHT BAR INSTALLATION INSTRUCTIONS

The light bar must be inspected before each use to make certain attachments are secure, and for evidence of wear. Misuse of the light bar or failure to observe the manufacturer's instructions as to installation, proper attachment and maintenance will void warranties that may be implied by law.

TOOLS REQUIRED FOR INSTALLATION:

- 1- Torx bit (T-40)
- 1- 13mm box or open end wrench
- 1- 15mm socket 3/8" drive with 10" extension
- 1- 5mm Allen wrench
- 1- 3/16" Allen wrench
- 1-1/2" box or open end wrench

CAUTION

**USE ANTI-SEIZE LUBRICANT
ON ALL SCREWS**

GOBI JEEP JL FRONT RACK SUPPORT/LIGHT BAR INSTALLATION INSTRUCTIONS

Guidelines:

When using Load Carriers and Accessories, the user must understand the precautions. The points listed below will assist you in using the rack /carrier system and will encourage safety.

- For quality fits and safety, use only the recommended rack or accessory. Do not assume an accessory will fit, always check with dealer when obtaining new accessories. Use only approved accessories on load carriers. Using other brands will void your warranty.
- Make sure all knobs, bolts, screws, straps, and locks are firmly attached, tightened and locked before every trip. Knobs, bolts, screws, straps, and locks must be periodically inspected for signs of wear, corrosion, and fatigue. Check your load at stops during the trip to insure continued fastening security.
- Check local and state laws governing projection of objects beyond the width of a vehicle. **Be aware of the width and height of your cargo since low clearance branches, bridges, and parking garages can affect the load** All cargo will affect the vehicle's driving behavior. Never drive with any lock, knob, or rack in an open or unlocked position. All long loads such as, but not limited to sailboards, surfboards, kayaks, canoes, and lumber must be tied down front and rear to the bumpers or tow hooks, of the vehicle.
- Remove your rack accessories when they are not in use, before entering car washes, prior to taking in your vehicle for service, and whenever clearance may be an issue.
- All locks must be turned and moved periodically to insure smooth operation. Use graphite or similar dry lubricant to help this. Locks are designed to deter vandalism and theft. Remove valuable gear if your vehicle is unattended for an extended period. Place at least one key in the glove compartment.
- For safety to your vehicle and rack system, obey all posted speed limits and traffic cautions. Adapt your speed to the conditions of the road and the load being carried.
- Do not use load carriers and accessories for purposes other than those for which they were designed. Do not exceed their carrying capacity.
- Consult with your dealer if you have any questions regarding the operations and limits of this product. Review all instructions carefully.

READ ALL INSTRUCTIONS PRIOR TO INSTALLATION

GOBI JEEP JL FRONT RACK SUPPORT/LIGHT BAR INSTALLATION INSTRUCTIONS

Included in kit

Letter	Description	Location	Quantity
A	GOBI JEEP JL STEALTH FRONT LIGHT BAR	Main box	1
B	GOBI LIGHT BAR COVER PLATES PASSENGER AND DRIVER	Hardware box	1
C	GOBI HINGE BRACKET AND BODY PANEL STRAP PASS AND DRIVER	BAG #2	1 ea.
D	<p>GOBI JEEP JL LIGHT BAR MOUNTING HARDWARE</p> <p><u>CONTENTS:</u></p> <p>4- 5/16-18 x 3/4" Button head screw SS 4- 5/16" Nylock nuts SS 4- M8 x 40mm Button head screw SS 4- 5/16" Lock washer SS 4- White nylon spacers (Bag #3a) 1- Packet Anti-seize lubricant 12- 5/16" Flat washers SS 2- Black 1/8" x 1" x 1/2" black adhesive backed pads — ■ ■ 2- Round brown adhesive backed wear pads — ● ●</p>	BAG #3 Hardware Box	1

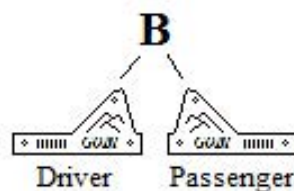
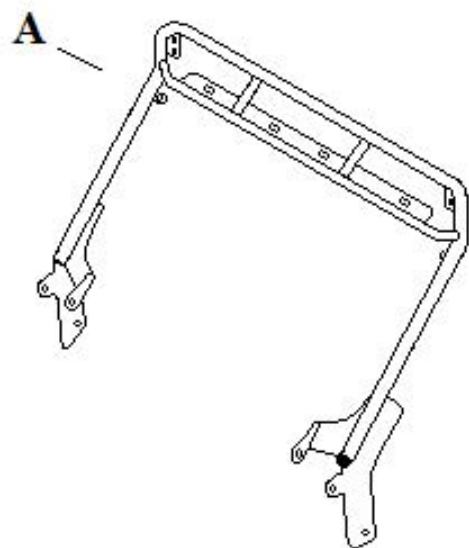

BAG #2

BAG #3

GOBI JEEP JL FRONT RACK SUPPORT/LIGHT BAR INSTALLATION INSTRUCTIONS

Qty. 4 | 5/16-8 x 3/4" Button Head Screw SS



Qty. 4 | M8 x 40mm Button Head Screw SS



Qty. 4 | Nylon Spacer



Qty. 12 | 5/16" Flat Washer SS



Qty. 4 | 5/16" Lock Washer SS



Qty. 4 | 5/16" Nylock Nuts SS

GOBI JEEP JL FRONT RACK SUPPORT/LIGHT BAR INSTALLATION INSTRUCTIONS

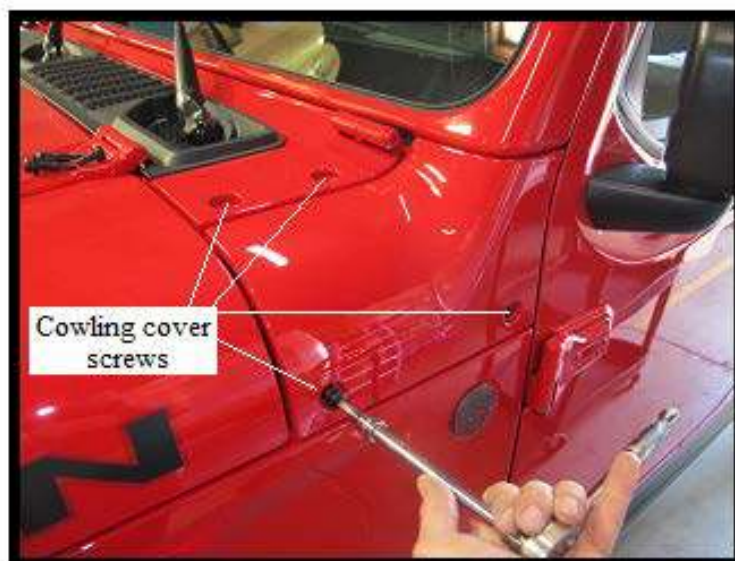
**Fig. 1**

Use a #40 Torx bit and remove the 4 outside cowling cover screws as shown in Fig. 1 and Fig. 2.

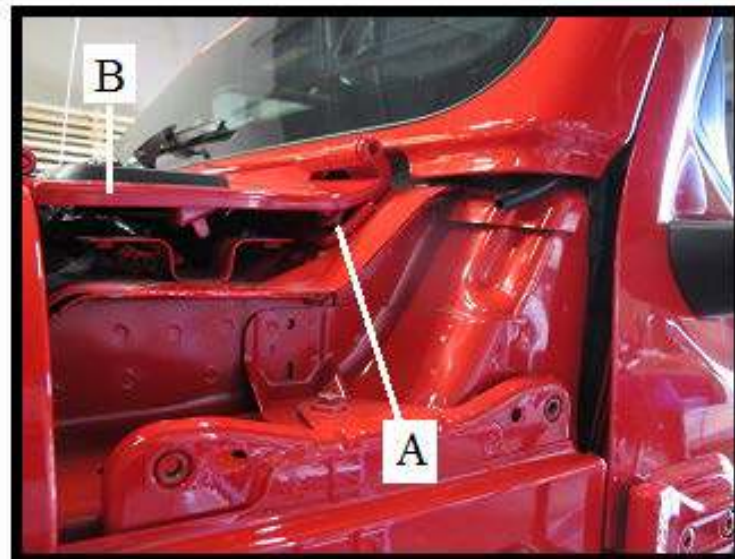
**Fig. 2**

While lifting slightly on cowling (B) to expose hinge screw (A) slide a 13mm box end wrench over the outside hinge screw (A) and loosen. Do not remove the hinge screw only loosen as shown in Fig. 3.

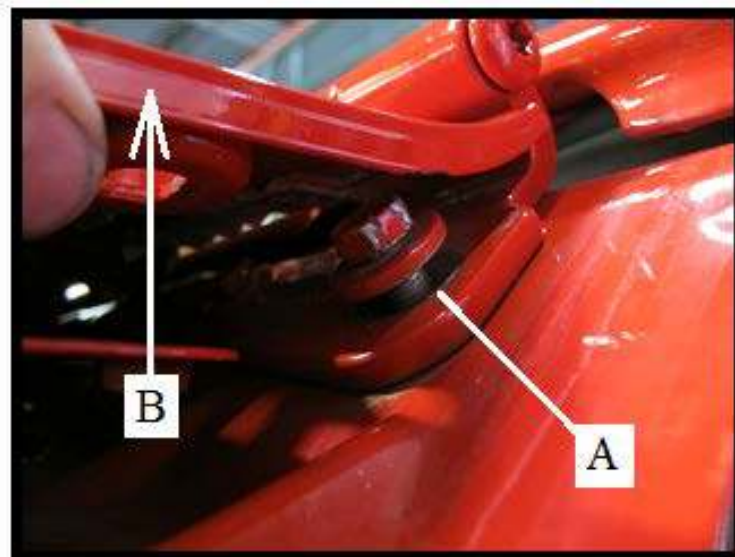
**Fig. 3**

Loosen hinge screw (A) enough to slide hinge bracket (F) located in Bag #2 of your hardware kit as shown in Fig. 4.

GOBI JEEP JL FRONT RACK SUPPORT/LIGHT BAR INSTALLATION INSTRUCTIONS

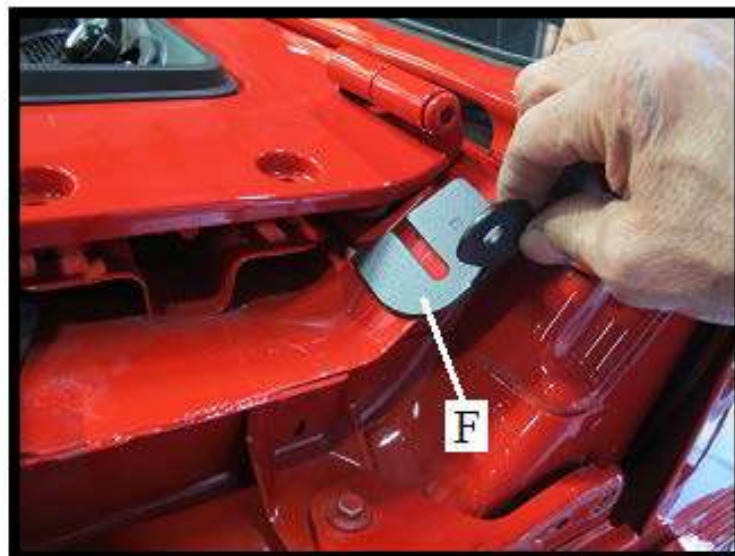
**Fig. 4**

Slide the passenger side hinge bracket (F) marked with a stamped letter (D) or label (indicating Driver side) under the outside hinge screw as shown in Fig. 4 and Fig. 5

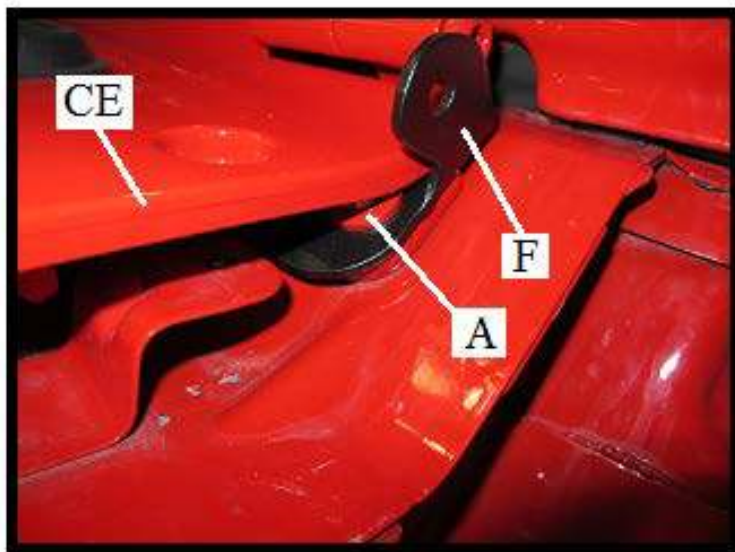
**Fig. 5**

Slide hinge bracket (F) as far inward as possible and line up with cowling edge (CE) and the outside windshield hinge as shown in Fig. 5 and Fig. 6

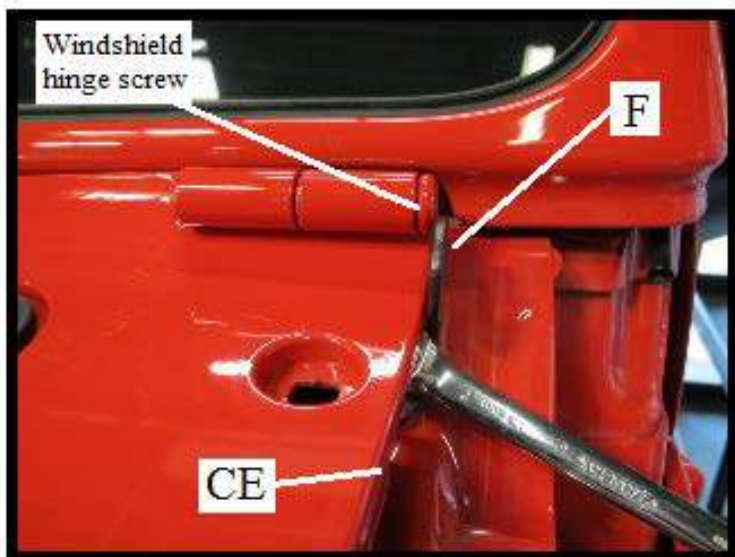
**Fig. 6**

Line up hinge bracket (F) with cowling edge (CE) and windshield hinge screw then fully tighten hinge screw (A) shown in Fig. 5 using a 13mm box end wrench

GOBI JEEP JL FRONT RACK SUPPORT/LIGHT BAR INSTALLATION INSTRUCTIONS

Fig. 7

Fully open the driver side door to expose the upper door hinge as shown.

Fig. 8

Use a 15mm ratchet with long extension and remove the upper hinge screw completely as shown.

Fig. 9

Remove body strap (S) driver side located in Bag #2 of your hardware kit as shown above

Fig. 10

Slide body strap (S) in between the door and body as shown in Fig. 10 above. Thread into the upper strap hole the same torx head screw removed earlier from the outside cowling as shown in Fig. 11.

Finger tighten only at this time. With the driver side door still open thread in the upper door hinge screw as shown in Fig. 12 through strap (S). Pull down on body strap (S) while fully tightening the door hinge screw.

Fig. 11**Fig. 12****Fig. 13**

Remove cowling screw as shown above in Fig. 13

Fig. 14

Place a piece of 1" x 1/2" black foam tape located in Bag #3 at the location shown in Fig. 14 and Fig. 15

Fig. 15

Install cowling as shown above using only the top 2 screws. Leave out the lower cowling screws as shown. Repeat the same process for the opposite side.

GOBI JEEP JL FRONT RACK SUPPORT/LIGHT BAR INSTALLATION INSTRUCTIONS

Fig. 16**Fig. 17****Fig. 18**

SKIP FIGURES 16 THRU 18 IF NO WIND DEFLECTOR IS TO BE INSTALLED

Remove a roll of clear protective film from your wind deflector hardware package strapped onto the roof rack. Clean the windshield frame as shown in Fig. 16 with denatured alcohol. Peel off the protective backing on the clear protective film and apply over the windshield onto the windshield frame as shown in Fig. 17. Once you press the film onto the frame cut the overage at the opposite side so that both ends start and end at approximately the curvature of the windshield glass.

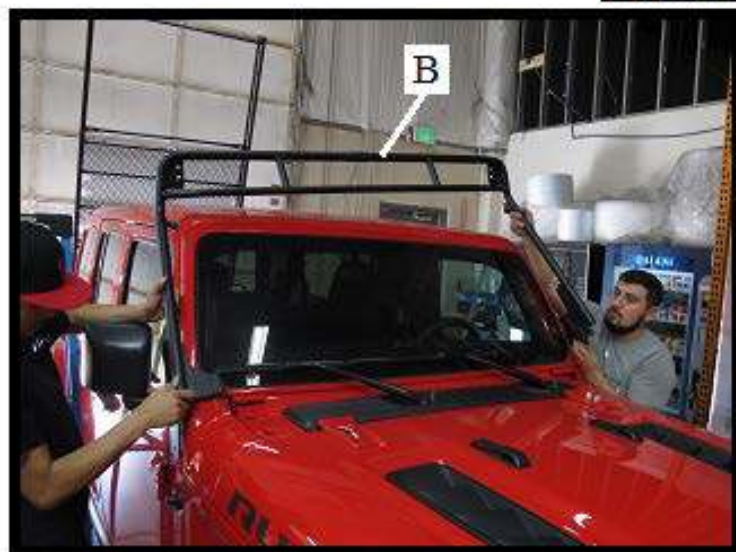
Fig. 19**Fig. 20**

Install the Gobi light bar (B) as shown in Fig. 19 one side first. Make sure to place a white nylon spacer (1) located in Bag #3 of your hardware kit into the cowling mounting hole recess shown in Fig. 20.

**Fig. 21**

Remove 1- Button head Allen screw M8 x 40mm, 1- 5/16" lock washer and 1- 5/16" flat washer located in Bag #3 of your hardware kit. Thread screw, lock washer and flat washer into light bar, nylon spacer (1) then into vehicle body as shown in Fig. 21. Finger tighten only at this time.

GOBI JEEP JL FRONT RACK SUPPORT/LIGHT BAR INSTALLATION INSTRUCTIONS

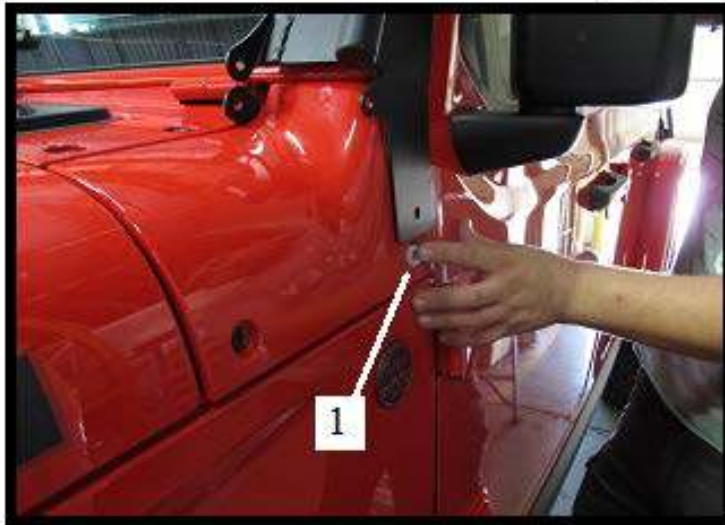
Fig. 22**Fig. 23**

Place another spacer (1) into the mounting recess hole as shown in Fig. 22 in the same manner as the passenger side. Pull down the Gobi light bar over the spacer and thread in 1- Button head Allen screw M8 x 40mm, 1- 5/16" lock washer and 1- 5/16" flat washer as shown in Fig. 23. Snug down only at this time.

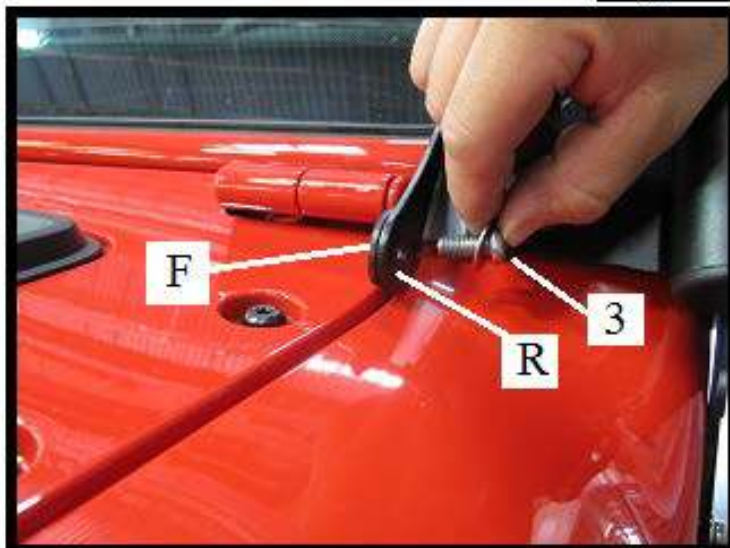
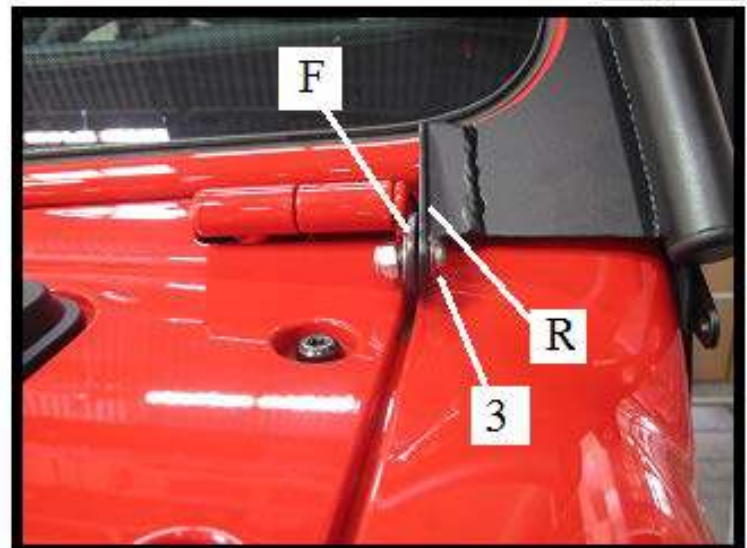
Fig. 24**Fig. 25**

Pull the light bar up or down in or out to line up hole of light bar flange (R) with the hole in hinge bracket (F) as shown in Fig. 24. Slip in 1-5/16 x 3/4" button head Allen screw and 1-5/16" flat washer (3) located in Bag #3 as shown in Fig. 24 and 25. Use another 5/16" flat washer and 1- 5/16" nylock nut also located in Bag #3 and snug down using a 1/2" box end wrench and 3/16" Allen wrench. Apply the same procedure to the opposite side.

GOBI JEEP JL FRONT RACK SUPPORT/LIGHT BAR INSTALLATION INSTRUCTIONS

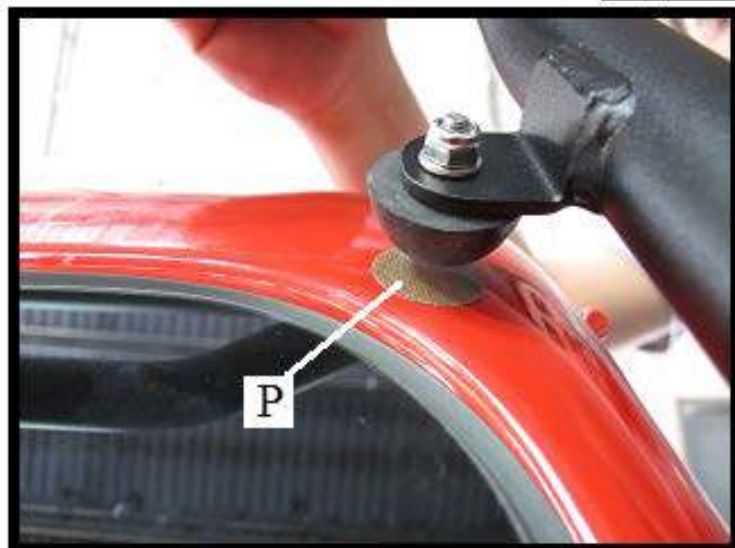
Fig. 26

Remove from Bag #3 1- Brown adhesive backed wear pad (P). Peel off the adhesive protective cover and stick to the windshield frame directly under the rubber bumper of the light bar as shown in Fig. 26. Apply the same procedure to the opposite side.

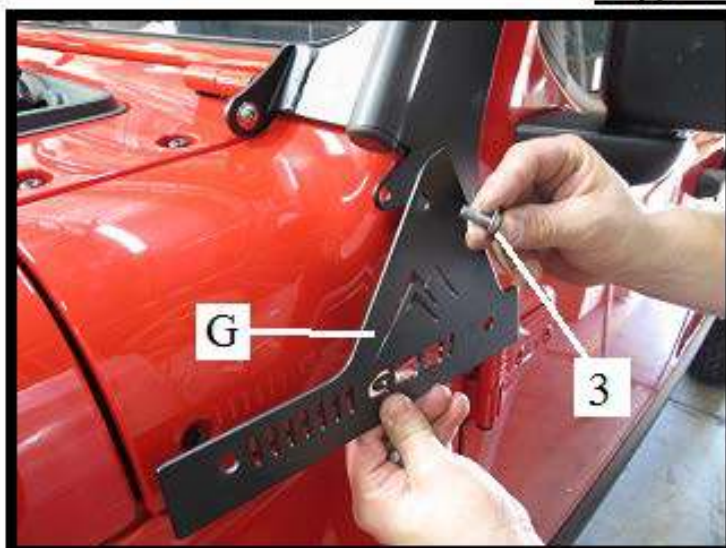
Fig. 27

Remove the driver side light bar cover plate (G) from your hardware box. Install the driver side cover plate (G) onto the light bar as shown in Fig. 27 using 1- 5/16 x 3/4" Allen head screw and 1- 5/16" flat washer (3). Use another 5/16" flat washer and 1- 5/16" nylock nut to secure in place and snug down only at this time.

Fig. 28

Remove the lower light bar M8 x 40 mounting screw (4) as shown in Fig. 28. Then slide cover plate (G) over the top of lower light bar and line up holes as shown in Fig. 29. Tread back mounting screw M8 x 40 into cover plate (G) and lower light bar and leave finger tight only. Remove 1- white nylon spacer (1) from Bag #3 and slip behind cover plate (G) as shown in Fig. 30 in the second cowling recess hole. Thread another M8 x 40mm Allen head screw, 1- 5/16" lock washer and 1- 5/16" flat washer located in Bag #3 into the cover plate (G) and snug down only at this time.

Fig. 29**Fig. 30**

GOBI JEEP JL FRONT RACK SUPPORT/LIGHT BAR INSTALLATION INSTRUCTIONS

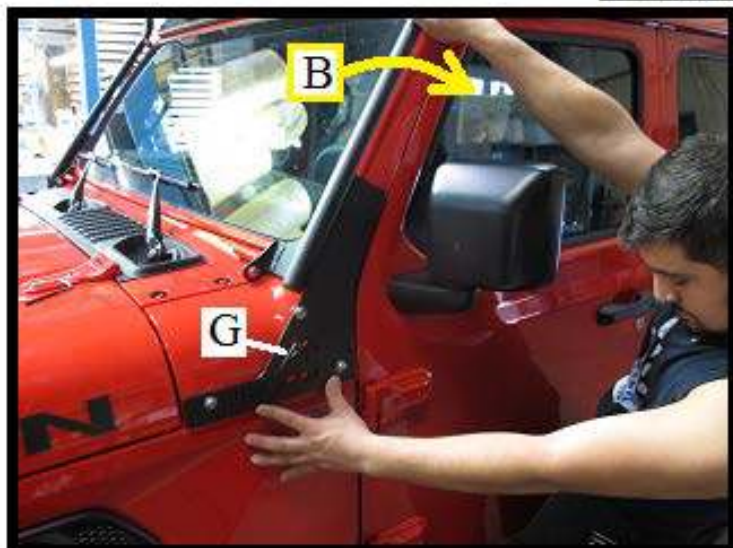
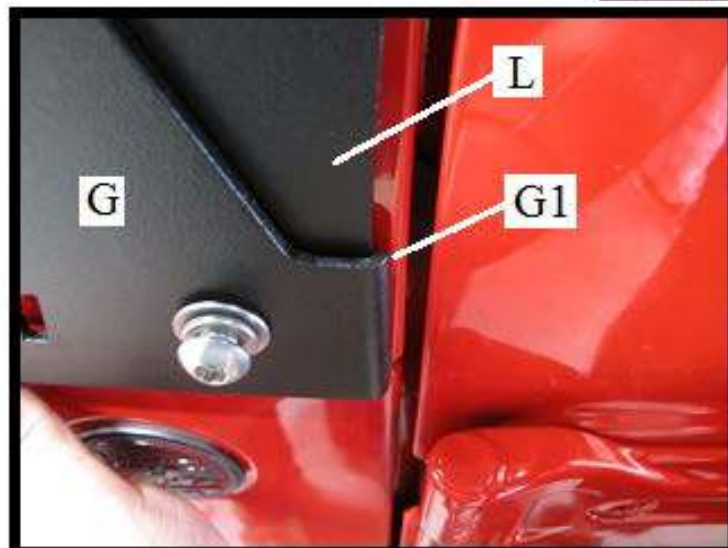
Fig. 31**Fig. 32**

Pull back on the top of light bar (B) towards the vehicle as shown in Fig. 31 by the arrow. Keep pressure on the light bar while making sure hook (G1) of cover plate (G) slips over the back of light bar base plate (L) as shown in Fig. 32.

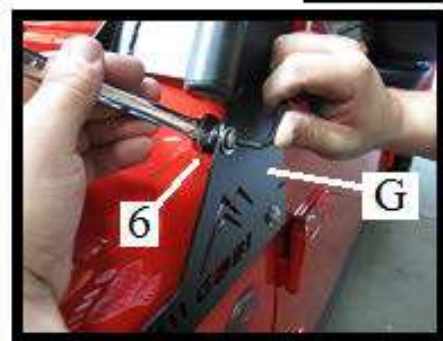
Fig. 33**Fig. 34****Fig. 35**

With the hook section of cover plate (G) over the back of the light bar base plate (L) as shown in Fig. 32 fully tighten the M8 x 40mm screw (4) using a 5mm Allen wrench as shown in Fig. 33. Make sure cover plate (G) is even with the body lines and fully tighten the second M8 x 40mm screw (5) as shown in Fig. 34. Proceed to the top of cover plate (G) and fully tighten the 5/16 Allen screw (6) using a 3/16" Allen wrench and 1/2" box end wrench.

Fig. 36

Fully tighten the 5/16" Allen screw and nylock nut (A) securing hinge bracket (F) and light bar flange (R) in place using a 3/16" Allen wrench and 1/2" box end wrench. Apply the same procedure to the opposite side.

GOBI JEEP JL FRONT RACK SUPPORT/LIGHT BAR INSTALLATION INSTRUCTIONS



GOBI Wind Deflector sold separately*

GOBI JEEP JL LIGHT BAR INSTALLATION COMPLETED

Recommended Attachments:

- A) Gobi Jeep JL wind deflector

To purchase these or other Gobi accessories please contact a Gobi online dealer or Gobi Racks direct at 1-720-479-9372 or e-mail to sales@gobiracks.com Thank you for your purchase