

GOBI JEEP JK 45 SLANT BACK WRANGLER ROOF RACK for Bestop TrekTop NX soft top **INSTALLATION INSTRUCTIONS**

The rack must be inspected before each use to make certain attachments are secure, and for evidence of wear. Misuse of the rack or failure to observe the manufacturer's instructions as to installation, proper Attachment and maintenance will void warranties that may be implied by law.

TOOLS REQUIRED FOR INSTALLATION:

- 1- 15mm socket or box end wrench (rear bumper)**
- 1- 7/16" socket or box end wrench (light bar clamps)**
- 1- 9/16" socket or box end wrench (rear tower and rack)**
- 1- 3/4" socket and 3/4" box end or adjustable wrench (rear bar)**
- 1- 1/2" open end wrench (isolators)**
- 1- Torx bit T-40 (light bar)**

CAUTION

**USE ANTI-SEIZE LUBRICANT
ON ALL SCREWS**

GOBI JEEP JK 45 SLANT BACK WRANGLER ROOF RACK for Bestop TrekTop NX soft top INSTALLATION INSTRUCTIONS

Guidelines:



When using Load Carriers and Accessories, the user must understand the precautions. The points listed below will assist you in using the rack /carrier system and will encourage safety.

- For quality fits and safety, use only the recommended rack or accessory. Do not assume an accessory will fit, always check with dealer when obtaining new accessories. Use only approved accessories on load carriers. Using other brands will void your warranty.
- Make sure all knobs, bolts, screws, straps, and locks are firmly attached, tightened and locked before every trip. Knobs, bolts, screws, straps, and locks must be periodically inspected for signs of wear, corrosion, and fatigue. Check your load at stops during the trip to insure continued fastening security.
- Check local and state laws governing projection of objects beyond the width of a vehicle. **Be aware of the width and height of your cargo since low clearance branches, bridges, and parking garages can affect the load** All cargo will affect the vehicle's driving behavior. Never drive with any lock, knob, or rack in an open or unlocked position. All long loads such as, but not limited to sailboards, surfboards, kayaks, canoes, and lumber must be tied down front and rear to the bumpers or tow hooks, of the vehicle.
- Remove your rack accessories when they are not in use, before entering car washes, prior to taking in your vehicle for service, and whenever clearance may be an issue.
- All locks must be turned and moved periodically to insure smooth operation. Use graphite or similar dry lubricant to help this. Locks are designed to deter vandalism and theft. Remove valuable gear if your vehicle is unattended for an extended period. Place at least one key in the glove compartment.
- For safety to your vehicle and rack system, obey all posted speed limits and traffic cautions. Adapt your speed to the conditions of the road and the load being carried.
- Do not use load carriers and accessories for purposes other than those for which they were designed. Do not exceed their carrying capacity.
- Consult with your dealer if you have any questions regarding the operations and limits of this product. Review all instructions carefully.

GOBI JEEP JK 45 SLANT BACK WRANGLER ROOF RACK for Bestop TrekTop NX soft top

INSTALLATION INSTRUCTIONS

Included in kit

Letter	Description	Location	Quantity
A	GOBI JEEP JK 45 SLANT BACK WRANGLER ROOF RACK	Main box	1
B	GOBI JEEP JK 45 WRANGLER FRONT LIGHT BAR	Strapped to Rack	1
C	GOBI JEEP JK 45 REAR RACK SUPPORTS PASSENGER & DRIVER	Strapped to Rack	1 ea.
D	REAR RACK SUPPORT TOWERS PASSENGER AND DRIVER	Hardware Box	1 ea.
E	REAR TOWER SUPPORT PLATES PASSENGER AND DRIVER	Hardware Box	1 ea.
F	GOBI FRONT LIGHT BAR CLAMPS	BAG #2	2
G	GOBI WINDSHIELD BODY PROTECTION	BAG #3	2
H	MINI WIND DEFLECTORS	BAG #4	4
I	<p>GOBI RACK MOUNTING HARDWARE</p> <p><u>CONTENTS:</u> 4- Black nylon shoulder washers 4- 1/2" Flat washer SS 2- 1/2" x 2-1/2" hex head screw SS 2- 1/2" Nylock nuts SS 8- 3/8-16 x 1-1/4" hex head screw SS 24- 3/8" Flat washer SS 16- 3/8" Nylock nuts SS 4- 3/8" x 1" Carriage screws SS</p> <p>1- Packet Anti-seize lubricant 4- Rear support bar position plates  (P) 4- 1/4-20 x 1" hex head screw SS 4- 1/4" lock washer SS 4- 1/4" flat washer SS 2- 1-1/2" x 1-1/2" brown wear pad</p>	<p>BAG #5 Hardware Box</p> <p>Bag #2</p>	1
J	<p>GOBI RACK ISOLATOR HARDWARE</p> <p><u>CONTENTS:</u> 2- Black Triangular adhesive backed wear plates (Place on vehicle body under Rubber Isolators 21)  2- Oval Black aluminum adhesive backed wear plate (Place on vehicle body under Tower stand offs 12) </p>	<p>BAG #6 Hardware Box</p>	1

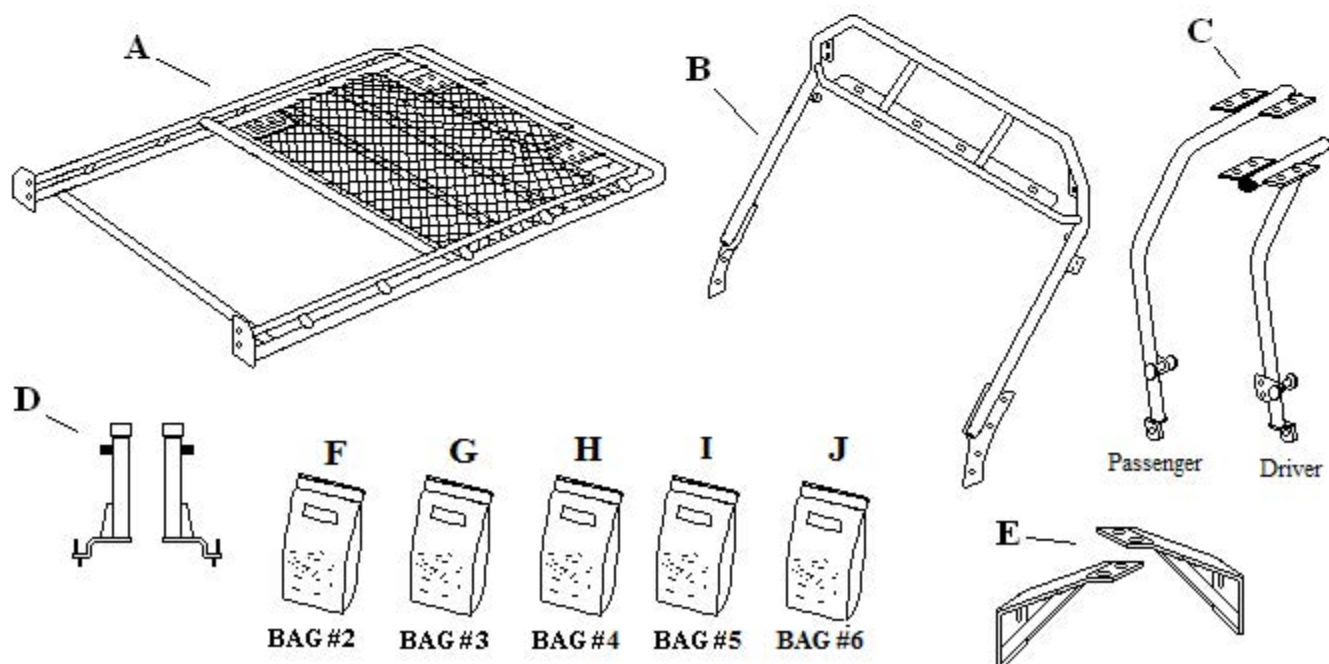

GOBI JEEP JK 45 SLANT BACK WRANGLER ROOF RACK

for Bestop TrekTop NX soft top

INSTALLATION INSTRUCTIONS

Fig. 1**Fig. 2**

Remove from your hardware kit windshield body protection covers (G) located in Bag #3. Take out the passenger side cover indicated by the letter (P) on the front lip of the cover as shown in Fig.1. Place the cover on the passenger side top corner of your windshield as shown in Fig. 2 and Fig. 3 shift the cover around slightly until it sits firmly on the corner of the windshield then place a piece of masking tape on the windshield next to both edges of the cover as shown in Fig. 3 to indicate position.

Fig. 3**Fig. 4**

Remove the cover from the masking tape markers and clean the area inside the masking tape markers with denatured alcohol let dry for 30 seconds then peel off the adhesive protective film from inside the cover as shown in Fig. 4 and set back inside masking tape markers placing the lip of the cover back into the recess on the edge of the windshield glass as shown in Fig. 2 then set the entire cover on the windshield frame as shown in Fig. 3 pressing down firmly for at least 30 seconds. Apply the same procedure to the driver side.

GOBI JEEP JK 45 SLANT BACK WRANGLER ROOF RACK

for Bestop TrekTop NX soft top

INSTALLATION INSTRUCTIONS

Fig. 5**Fig. 6**

Remove the rear triangular wear plates (I) located in Bag #6 of your hardware kit. Take out the passenger side wear plate as shown in Fig. 5 (*do not peel off the adhesive protective film at this time*) and place it on the rear upper passenger side corner of the body as shown in Fig. 6 move the wear plate around until it fits with the top formed edge of the body (A1) and contacts the rear tail light cover (A2) once you have a firm fit place a masking tape marker as shown in Fig. 6 to indicate position.

Fig. 7**Fig. 8**

Remove the cover from the masking tape marker and clean the area where the wear plate will sit with denatured alcohol let sit for 30 seconds to dry then peel off the adhesive protective film from the back of the wear plate as shown in Fig. 8 and set back onto the rear upper corner of the vehicle using the masking tape marker. Once set in place apply pressure for at least 30 seconds. Apply the same procedure to the driver side.

GOBI JEEP JK 45 SLANT BACK WRANGLER ROOF RACK

for Bestop TrekTop NX soft top

INSTALLATION INSTRUCTIONS

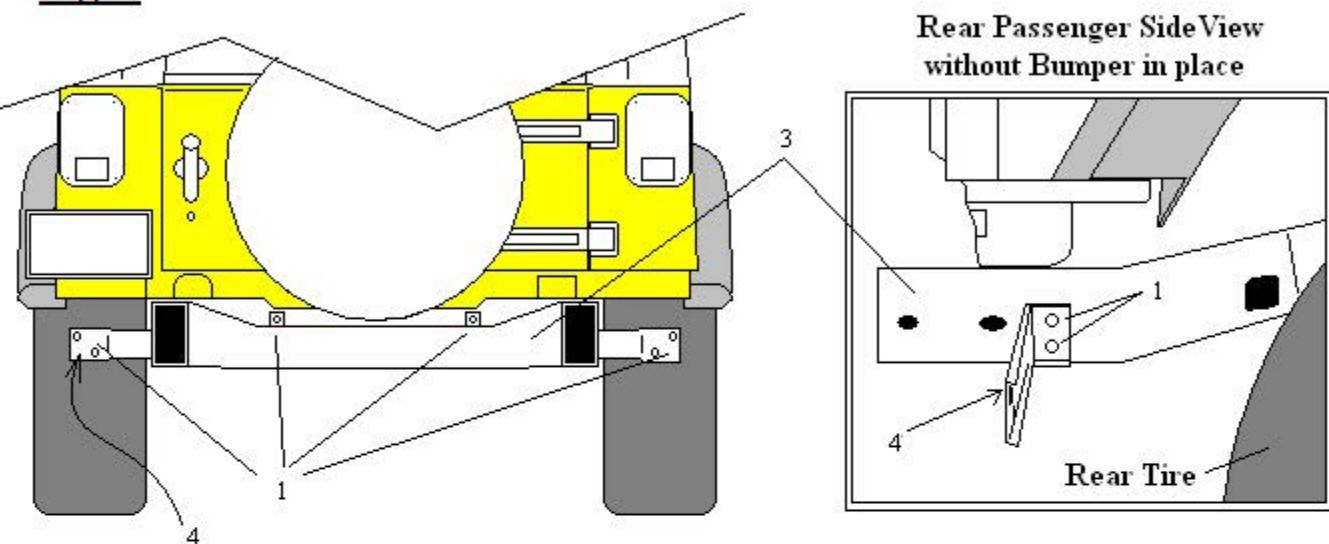
Fig. 9

Remove the rear bumper from vehicle as shown in Fig. 10 below by taking out all 6 10mm hex head screws (1) using a 15mm ratchet as shown in Fig. 9 above. Remove both rear bumper "L" brackets (4) as well and set under vehicle as they will be needed later.

Fig. 10

GOBI JEEP JK 45 SLANT BACK WRANGLER ROOF RACK

for Bestop TrekTop NX soft top

INSTALLATION INSTRUCTIONS

Fig. 11**Fig. 12**

If excess body puddy is present on rear body pinch seam as shown in Fig. 11 remove with plastic tool so that the body seam is free from any obstructions as shown in Fig. 12.

Fig. 13**Fig. 14**

Remove from your hardware box the passenger side support Tower (D) indicated by a printed label (PASSENGER SIDE) then slide Tower up onto the rear passenger side body pinch seam as shown in Fig. 13 and Fig. 14. Make certain that Tower (D) is pushed up as high as possible so that the curved section (C) of the Tower support plate mates with the curved area of the body as shown in Fig. 14, Fig. 15 and Fig. 16

GOBI JEEP JK 45 SLANT BACK WRANGLER ROOF RACK

for Bestop TrekTop NX soft top

INSTALLATION INSTRUCTIONS

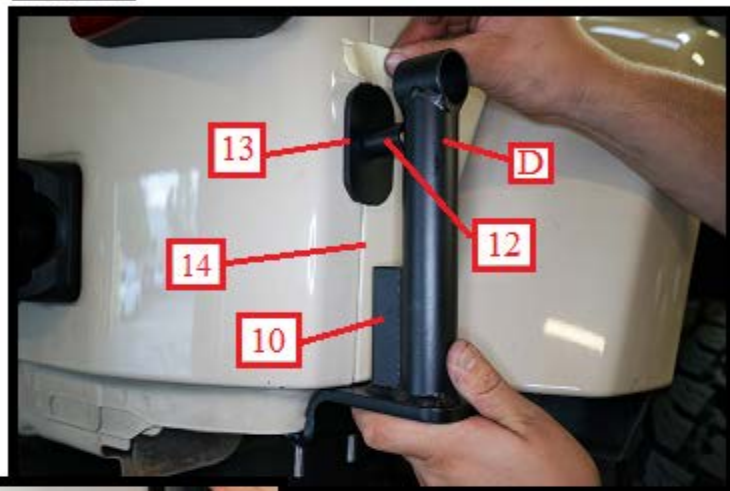
Fig. 15

After you have fully pushed up the passenger side support tower in place as shown in Fig. 16 and Fig. 15 align the tower flange (10) Fig. 15 and the center of the upper tower tube (11) Fig. 17 with body seam (14) and hold in place with one hand. Remove from your hardware kit Bag #6 one black oval wear plate (13) (*do not peel off the protective adhesive film*) and slide behind tower stand off (12) so that the center hole of plate (13) aligns with the center of the tower stand off (12) and body seam (14) hold plate and tower in place against vehicle body with one hand then stick a piece of masking tape on the body above the oval wear plate to use as a marker shown in Fig. 15 and Fig. 18. Remove tower (D) and wear plate (13) and clean off the surface area of the body where the oval plate will be placed with denatured alcohol then let dry for 30 seconds. Peel off the adhesive film from the wear plate and adhere the wear plate to the vehicle body under the masking tape marker and in line with body seam (14) as shown in Fig. 18.

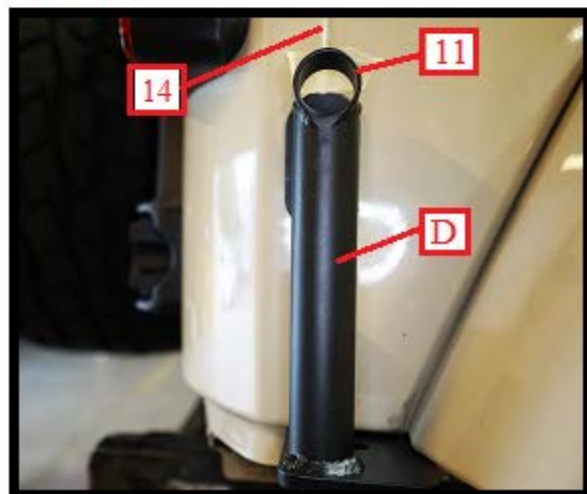
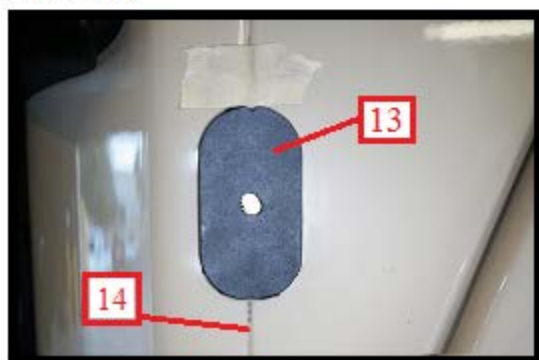
Fig. 16**Fig. 17****Fig. 18**

GOBI JEEP JK 45 SLANT BACK WRANGLER ROOF RACK
for Bestop TrekTop NX soft top**INSTALLATION INSTRUCTIONS****Fig.19**

Reinstall Tower (D) as shown in Fig. 15,16 and Fig. 17 then fully tighten both 3/8" hex head screws using a 9/16" ratchet or boxed end wrench as shown in Fig. 19.

Fig. 20

Apply Anti-Seize lubricant to both tower threaded studs as shown

Fig. 21

Tower threaded studs

Remove the Passenger side tower frame support (E) marked with a label (passenger side) from your hardware kit then install onto the tower threaded studs as shown in Fig. 21 and Fig. 22 using two 3/8" flat washers and two 3/8" nylock nuts located in Bag #4 of your hardware kit. Snug down, do not fully tighten leave some play for adjustment.

Fig. 22

GOBI JEEP JK 45 SLANT BACK WRANGLER ROOF RACK

for Bestop TrekTop NX soft top

INSTALLATION INSTRUCTIONS

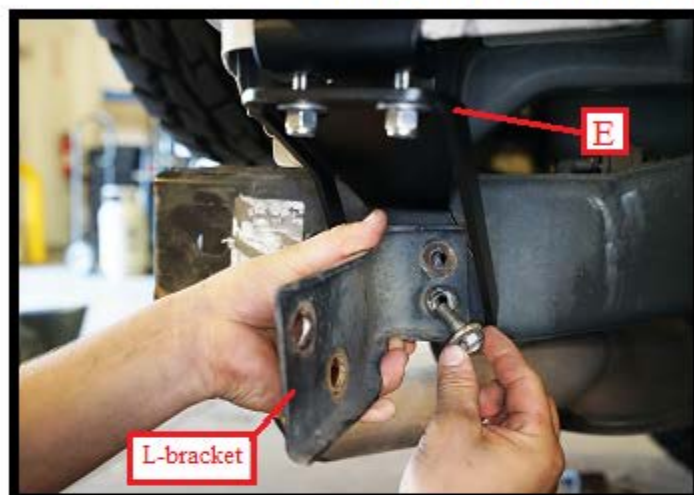
**Fig. 23**

Place passenger side "L" bracket into passenger side tower support (E) as shown in Fig. 23 and thread back the two OEM rear bumper screws and snug down, leave some play for adjustment.

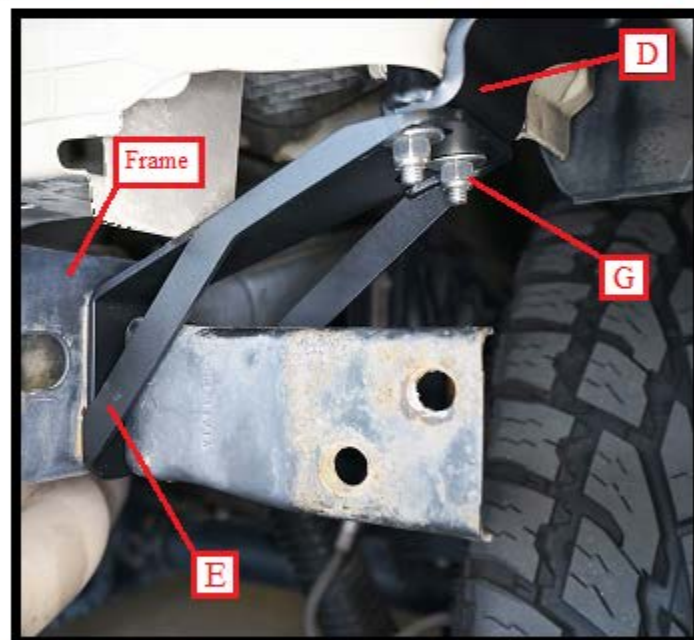
**Fig. 24**

IMPORTANT Push the tower support bracket (E) back against the frame as shown in Fig. 24 so that the support is in full contact with frame and snug down but leave loose enough to move up or down. Make certain that the tower support bracket (E) is now in full contact with the bottom of the tower support (D) as shown in Fig. 24 if a gap should appear move support (E) up to eliminate any space then fully tighten tower screws (G) to support bracket (E) continue to fully tighten support bracket (E) against the frame.

After you have fully tightened both ends of the tower frame support make certain the tower is making full contact with the body as shown in Fig. 25 no space between body and stand off (12). Pull the tower in the direction of the arrow you should get next to "0" movement. If you are able to pull tower far away from the body reinstall tower frame support (E) again until you get next to "0" movement. Apply the same procedure to the driver side tower installation.

Fig. 25

GOBI JEEP JK 45 SLANT BACK WRANGLER ROOF RACK for Bestop TrekTop NX soft top INSTALLATION INSTRUCTIONS

Fig. 26

Install rear bumper back in place and tighten all screws

Fig. 27

Finished tower install
Passenger side

Fig. 28

Finished tower install
driver side

Fig. 29**Fig. 30**

Remove the clear protective wear strip (K) attached to the back of the wind deflector strapped to the roof rack. Clean the area on the windshield frame just above the windshield as shown in Fig. 29 with denatured alcohol. Mix and apply the following formula to the windshield frame:

*Wetting Solution: 25% isopropyl alcohol, 75% distilled water, and 1 teaspoon dishwashing liquid per gallon. works best if dispensed from a spray bottle.

Apply above 50 deg. F to a surface that is free of dirt, grease and oil. Wide width applications should apply wetting solution * and plastic squeegee to remove trapped air.

Peel the clear protective tape from the paper backing and apply as shown in Fig. 30 then let dry for at least 30 minutes.

GOBI JEEP JK 45 SLANT BACK WRANGLER ROOF RACK
for Bestop TrekTop NX soft top
INSTALLATION INSTRUCTIONS**Fig. 31**

Remove 4 Torx head screws from the driver and passenger side windshield as shown above using a #40 TORX head bit.

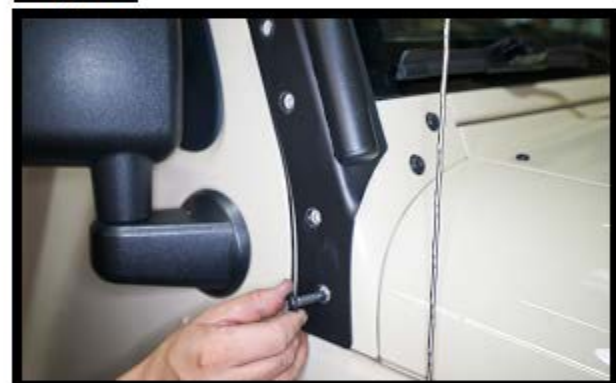
Fig. 33

Thread in the lower screw first as shown

Fig. 35

Thread in the remaining screws both sides, snug down only at this time.

Fig. 32

Install the Gobi light bar by sliding on the passenger side first as shown above

Fig. 34

Pull the driver side in place in the same manner as the passenger side and thread in the lower screw

Fig. 36

Remove clamp hook (R) from Bag #2 of your hardware kit

GOBI JEEP JK 45 SLANT BACK WRANGLER ROOF RACK

for Bestop TrekTop NX soft top

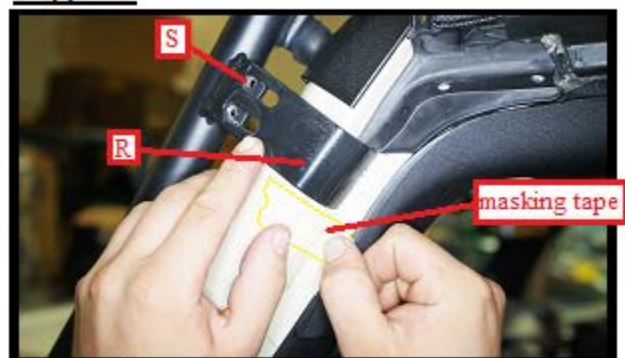
INSTALLATION INSTRUCTIONS**Fig. 37**

Place clamp hook (R) as shown inside door jam and align with screw holes (S) on light bar mount then place a piece of masking tape next to clamp edge on vehicle as shown

Fig. 39

Install clamp hook (R) over wear tape inside door jam and on light bar mount as shown above then place clamp plate (P) over clamp hook (R) and thread in two 1/4-20 x 1" hex head screws, lock washers and flat washers located in Bag#2 of your hardware kit. Snug down only at this time.

Fig. 41

Installation of light bar clamps completed

Fig. 38

Remove from Bag #2 a piece of brown wear tape and attach to inside door jam next to masking tape marker as shown above.

Fig. 40

Pull light bar back towards vehicle as shown and at the same time push clamp hook up against door jam then tighten both hex head screws fully. Apply the same procedure to the passenger side.

Fig. 42

Fully tighten all remaining Torx head light bar screws as shown driver and passenger sides. Light bar install completed

GOBI JEEP JK 45 SLANT BACK WRANGLER ROOF RACK

for Bestop TrekTop NX soft top

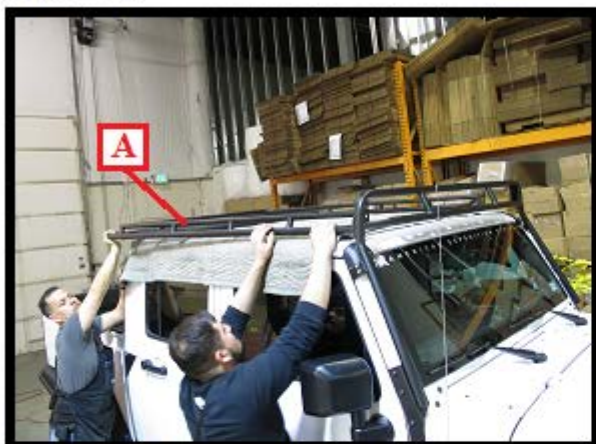
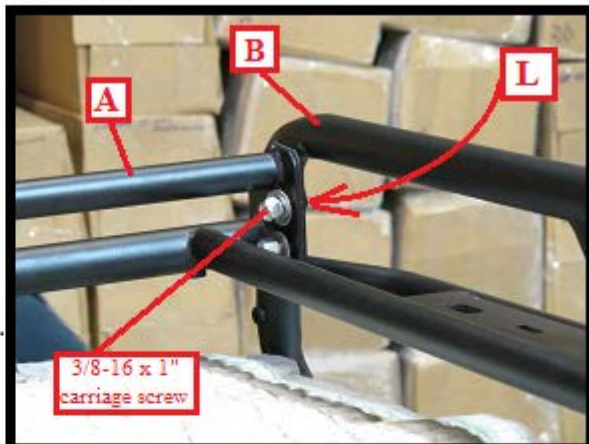
INSTALLATION INSTRUCTIONS**Fig. 40****Fig. 41**

Place a clean blanket over the top of your vehicle roof then slide the Gobi roof rack (A) with the help of another person over the roof top as shown in Fig. 40 up against the rear of light bar (B) shown in Fig. 41.

Use 4- 3/8-16 x 1" carriage screws two per side of light bar (B) located in Bag #4 of your hardware kit. Make certain that you push the screws in from the front of the light bar in the direction of red arrow (L) as shown in Fig. 41 then into the roof rack. Thread on 1- 3/8" flat washer and 1-3/8" nylock nut per screw and snug down. Do not fully tighten. With the soft top installed place a small piece or stack of wood approximaetly 4" tall under the rear center of the roof rack to help support the rack up and level during the installation of the rear support bars.

Fig. 42

Locate the passenger side rack support (C) as shown on page 3 of your hardware list and Fig. 42a. Place the top end of the rear support bar with the two welded in flanges under the rear passenger side roof rack and on the soft top as shown in Fig. 42a. Install as shown in Fig. 42 and Fig. 42a with the welded in tab (L) mounted to the outside of the passenger tower pivot socket. Use 1-1/2" hex head screw, 2-1/2" flat washers, 2-black nylon bushings and 1-1/2" nylock nut located in Bag #4 of your hardware kit in the order shown in Fig. 42. Snug down only at this time. Apply the same procedure to the driver side.

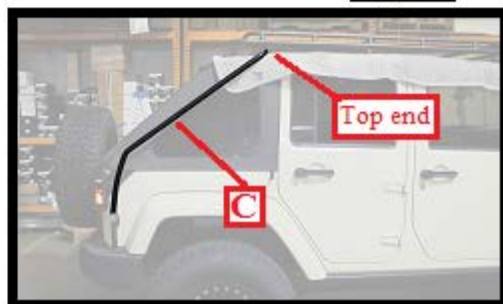
Fig. 42a

GOBI JEEP JK 45 SLANT BACK WRANGLER ROOF RACK

for Bestop TrekTop NX soft top

INSTALLATION INSTRUCTIONS

Fig. 43

Lift the rear passenger side corner of the roof rack and slip the rear passenger side support bar (C) under as shown in Fig. 43. Line up all four holes of the support bar welded in flanges (G) with the four holes in the roof rack support bar mount plate (F).

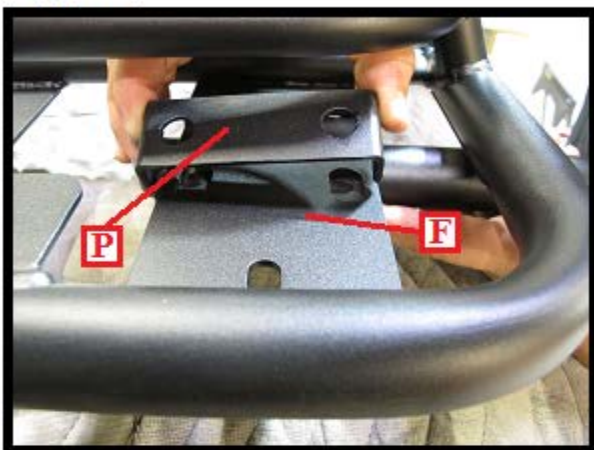
Fig. 44

Remove from Bag #4 of your hardware kit 2 rear support bar positioning plates (P) as shown in Fig. 44. Place positioning plates (P) over the roof rack support bar mount plate (F) and rear support bar welded in flanges (G) shown in Fig. 43.

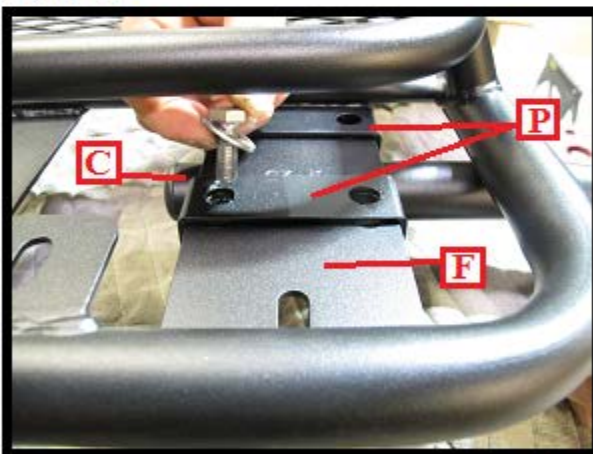
Fig. 45

Remove from Bag #4 of your hardware kit 4- 3/8-16x1" hex head screws, 8-3/8" flat washers and 4- 3/8" nylock nuts and secure both rear support bar positioning plates (P) in place as shown in Fig. 45. You may need to shake the rear support bar slightly while fitting plates (P) over both plate (F) and flanges (G) as this will facilitate assembly.

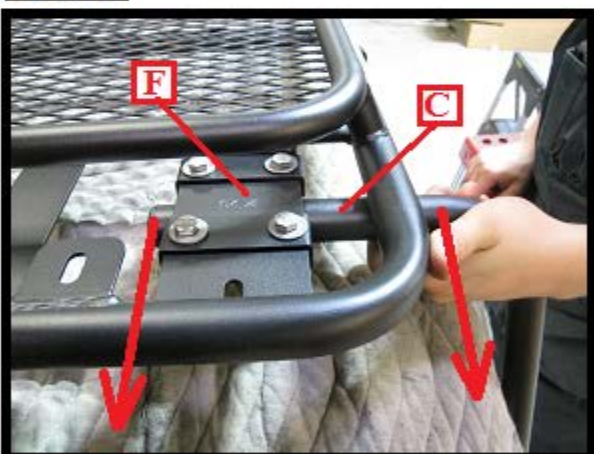
Fig. 46

After you have installed all four screws and nuts slide the rear support bar (C) as far rearward as possible indicated by the red arrows then fully tighten all screws. Apply the same procedure to the driver side rear support bar.

GOBI JEEP JK 45 SLANT BACK WRANGLER ROOF RACK

for Bestop TrekTop NX soft top

INSTALLATION INSTRUCTIONS

Fig. 55

Fully tighten passenger and driver rear pivot screws using a 3/4" ratchet and adjustable wrench or two 3/4" open end wrenches

Fig. 56

Lift up roof rack in direction of arrow both driver and passenger sides and hold in place then fully tighten using a 9/16" ratchet or open end wrench

Fig. 57

Turn isolator screws (10) clockwise until they make contact with wear plate (11) both passenger and driver sides

Fig. 58

Isolators must be turned in tightly to remove rear rack play. To make this process easy pull out on rear support bar (C) during each turn to reduce the pressure on the isolator. Make certain you apply at least 1 to 2 full turns each isolator both passenger and driver sides

Fig. 59

After you have properly tensioned both the driver and passenger side isolators set them in place by turning jam nut (M) 1/2 turn clockwise to prevent the isolators from loosening during travel

GOBI JEEP JK 45 SLANT BACK WRANGLER ROOF RACK

for Bestop TrekTop NX soft top

INSTALLATION INSTRUCTIONS



Roof rack installation completed

CAUTION:

- * DO NOT REST THE GOBI ROOF RACK ON THE REAR BUMPER AS DAMAGE CAN RESULT FROM THE WEIGHT OF THE ROOF RACK ON THE REAR LICENSE PLATE FRAME OR PLASTIC BUMPER.
- * EXCESSIVE SPEEDS OVER ROUGH TERRAIN WITH OR WITHOUT A FULLY LOADED ROOF RACK ARE NOT RECOMMENDED.
- * DO NOT EXCEED 200 LBS. CARGO WEIGHT ON ROOF RACK WITHOUT THE USE OF BOTH REAR LADDERS.

Recommended Attachments:

- A) "QUICK RELEASE" part #GJJKQR for easy and quick release of the roof rack for soft top retraction.
- B) "Upper rear Isolators" part #GJJKRUI prevents rear upper roof rack movement during high speed off road driving or extreme heavy loads. For hard top use only.

To purchase these or other Gobi attachments please contact a Gobi online dealer or Gobi Racks direct at 1-720-479-9372 or e-mail to sales@gobiracks.com Thank you for your purchase